

ADVANCED TECHNOLOGY
MADE IN AUSTRALIA

BENNETT DION

★ SURFBOARD
FOAM SYSTEMS ★

Shortboard Type

Bennett-Dion AUST.

Speed Shape Model

5'11"FRSS

Rocker 13.45cm

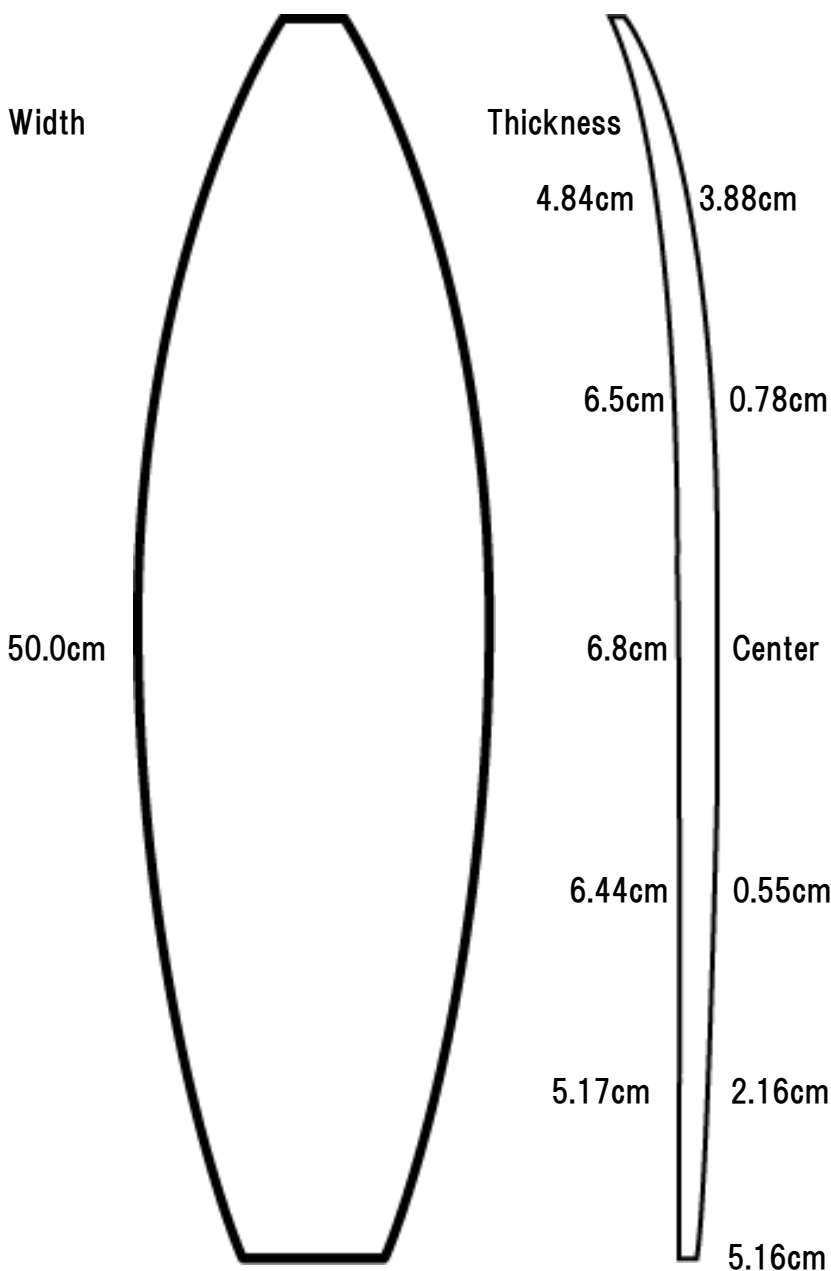

Deck Length	5'11
Max. Width	50cm
Max.Thickness	6.8 cm~
History	2016
Rocker	FR
Weights	UL
Stringer	1/8

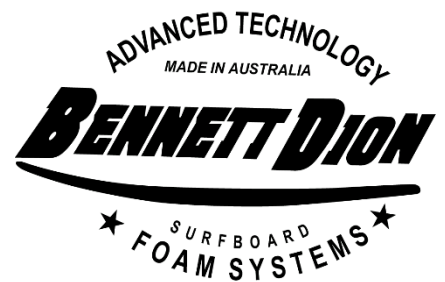

データ数値はあくまで参考値

*アウトラインはカットされておりません (使用フォームによりアウトライン異なります)

Performance to all-rounder

Bennett-Dion AUST.

Speed Shape Model

6'2"FRSS

Rocker 14.01cm

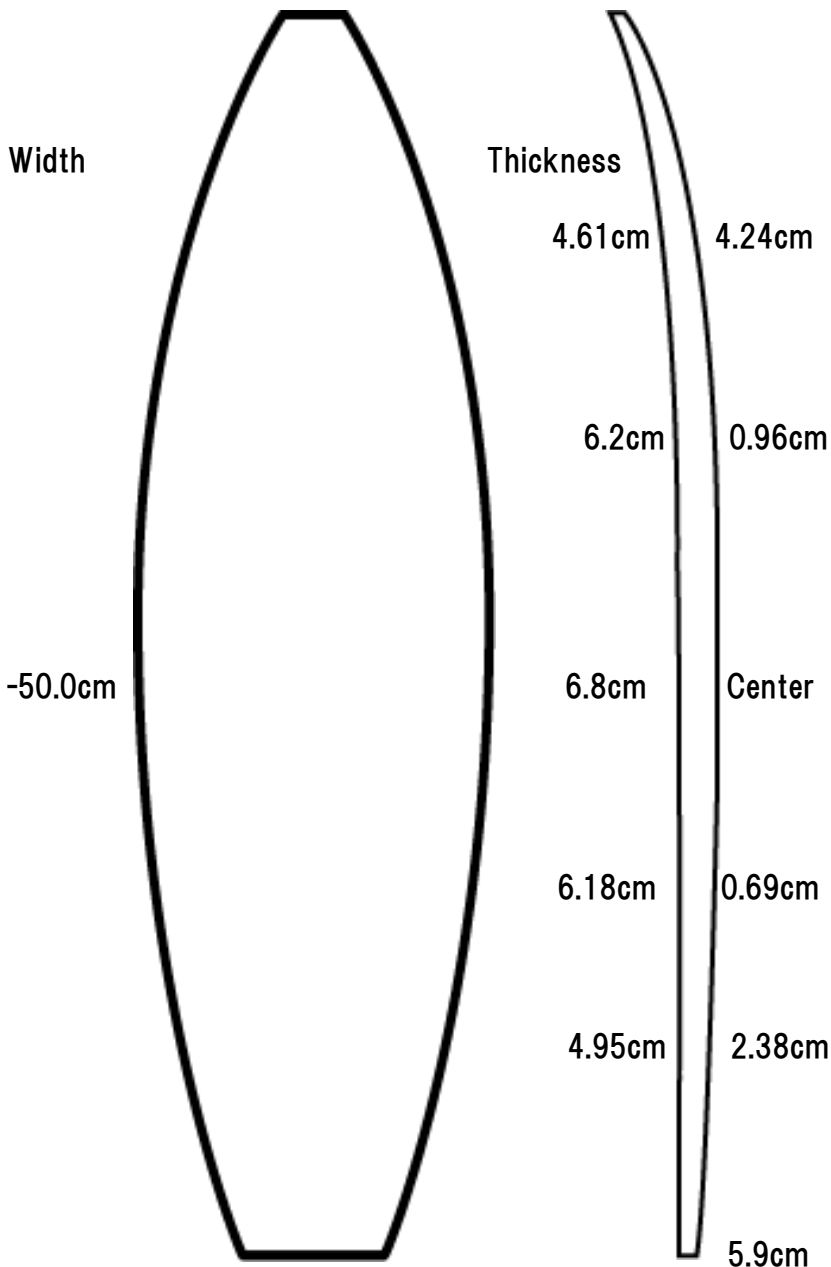

Deck Length	6'2
Max. Width	50cm
Max.Thickness	6.8 cm~
History	2016
Rocker	FR
Weights	UL
Stringer	1/8

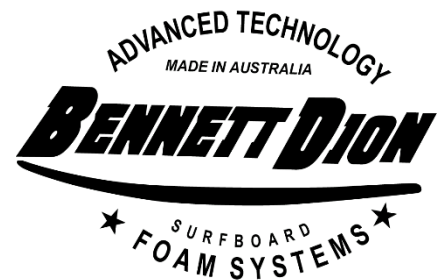

データ数値はあくまで参考値

*アウトラインはカットされておりません (使用フォームによりアウトライン異なります)

for performance or all-rounder

 **Peak of Japan**

Bennett-Dion AUST.

6'4"-D10

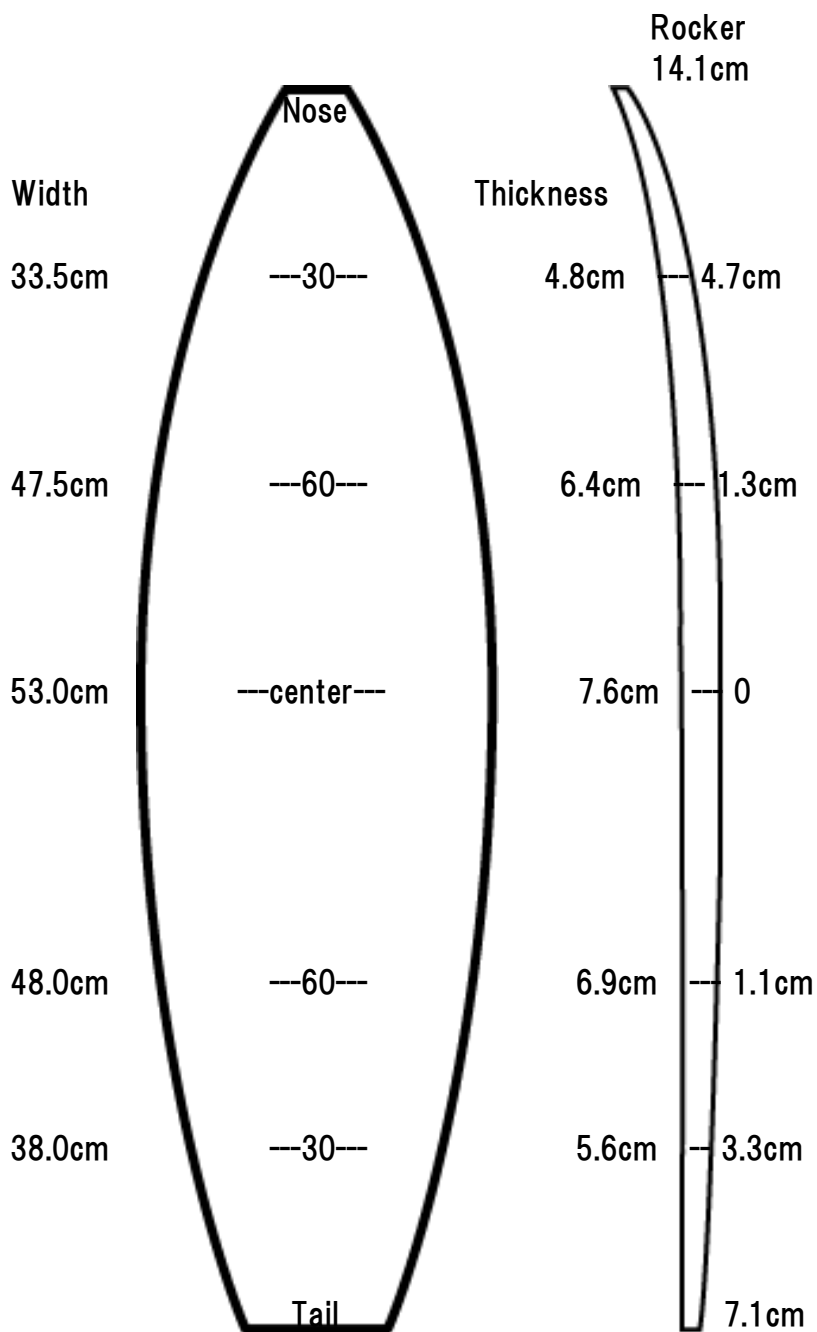

Bottom Length	198cm
Max. Width	53.0cm
Max. Thickness	7.6cm
History	2019
Rocker	D10
Weights	UL Team Pro
Stringer	1/8

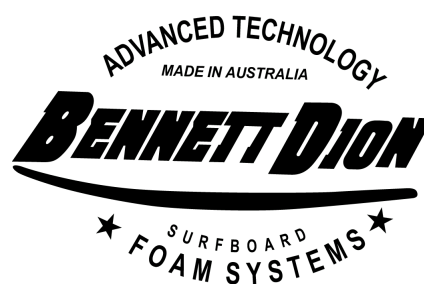

*数値はあくまで目安の参考値

Bennett-Dion AUST.

6'4-D19

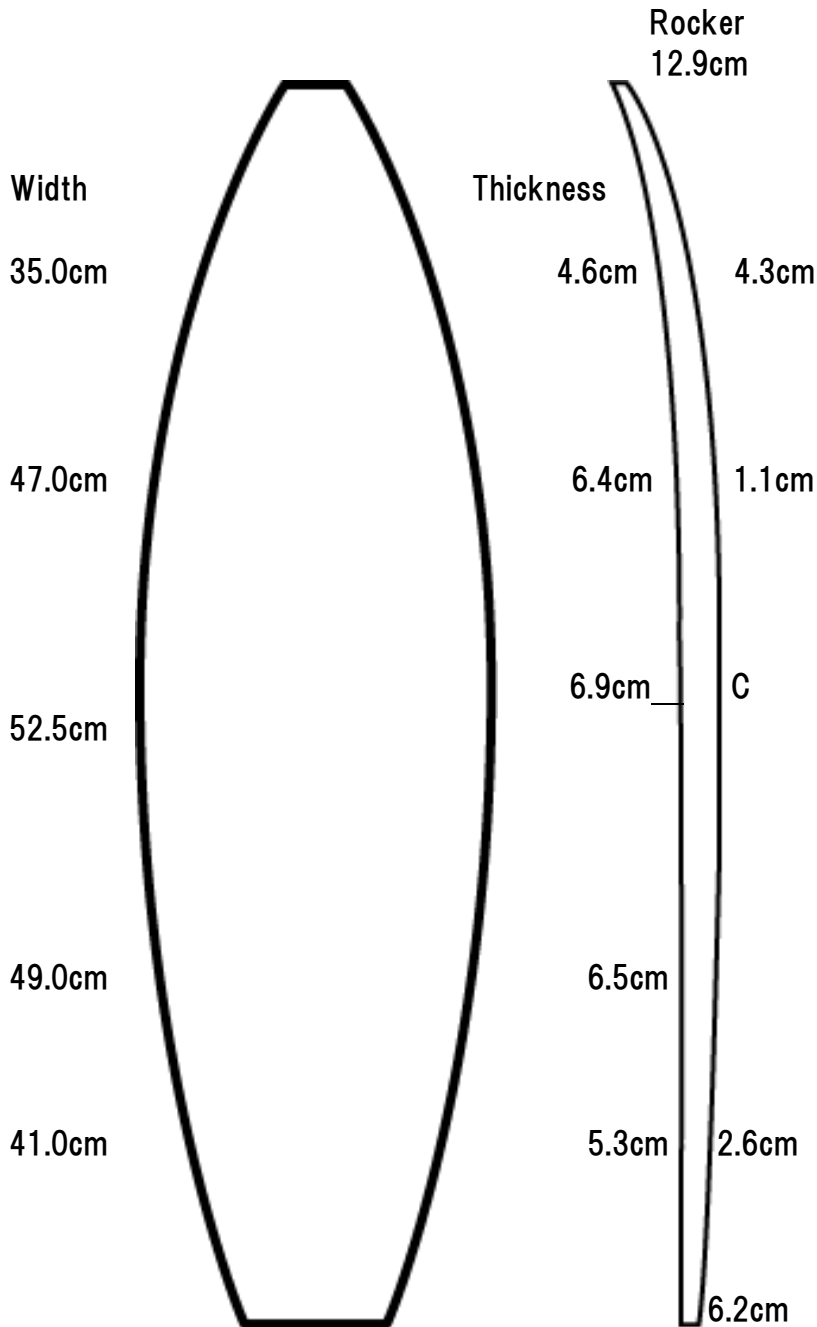

Bottom Length	195cm
Max. Width	52.5cm
Max. Thickness	6.9cm
History	2013
Rocker	671010
Weights	UL Team Pro
Stringer	1/8

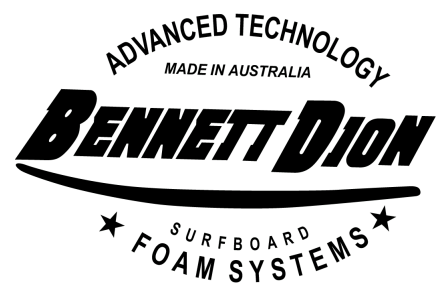

*for performance or all-rounder
natural and versatile curve
applied to 6'7 plug*

Bennett-Dion AUST.

6'4-mor

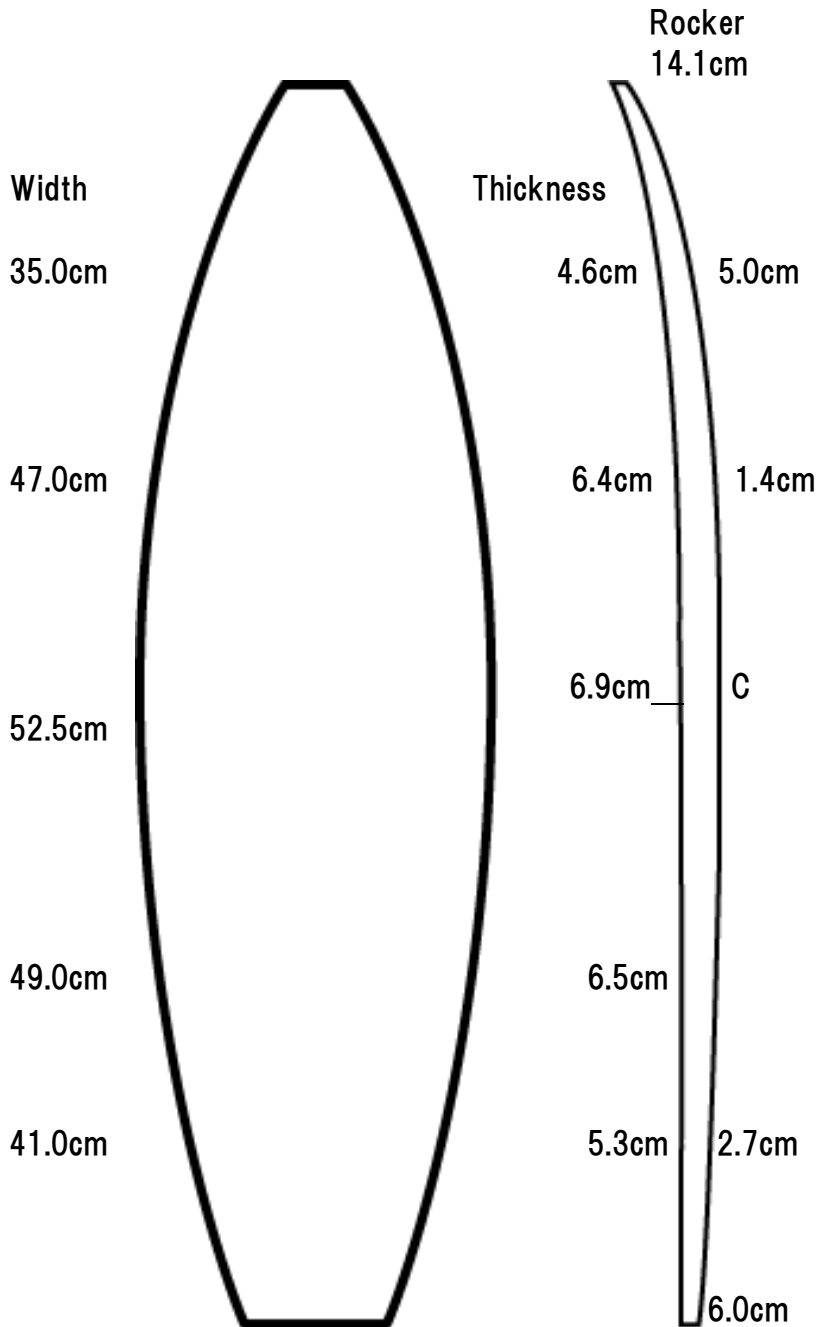

Bottom Length	195cm
Max. Width	52.5cm
Max.Thickness	6.9cm
History	2014
Rocker	67mor
Weights	UL Team Pro
Stringer	1/8

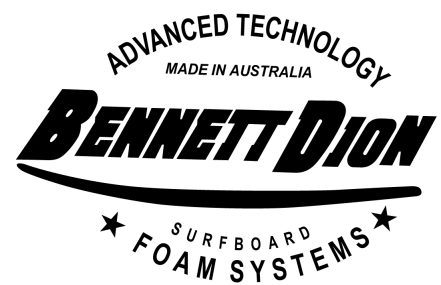

*Curvy rocker for performance or all-rounder
Full model change from 6'4D3 model
applied to 6'7 plug*

Bennett-Dion AUST.

6'7" D47

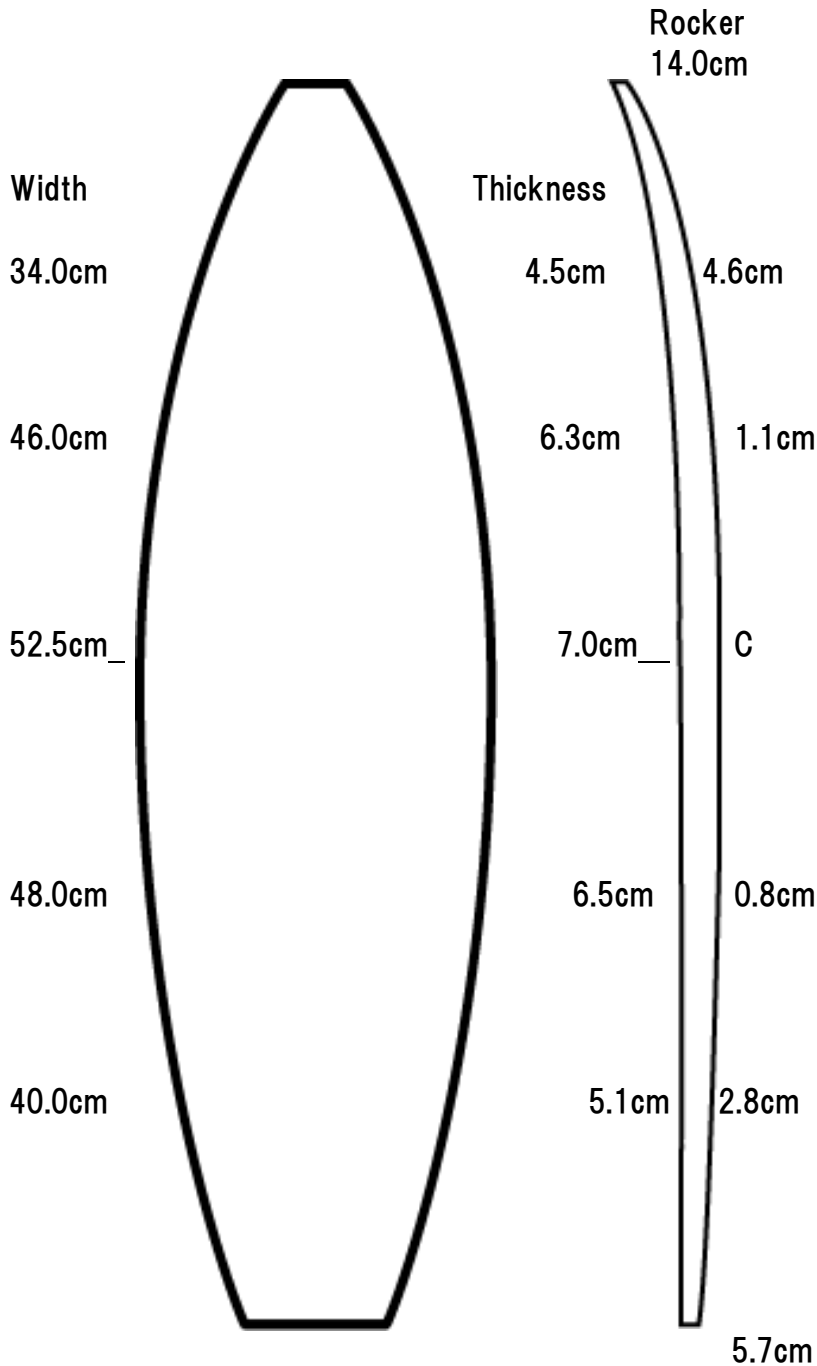

Actual Bottom Length	203.5cm
Max Width	52.5cm
Max Thickness	7.0cm
History	2013
Rocker	POJ4
Weights	UL
Stringer	1/8

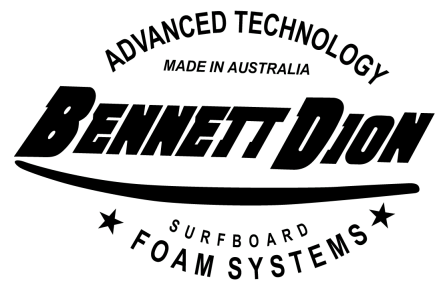

for performance or all-rounder

*数値はあくまで目安参考値

Bennett-Dion AUST.

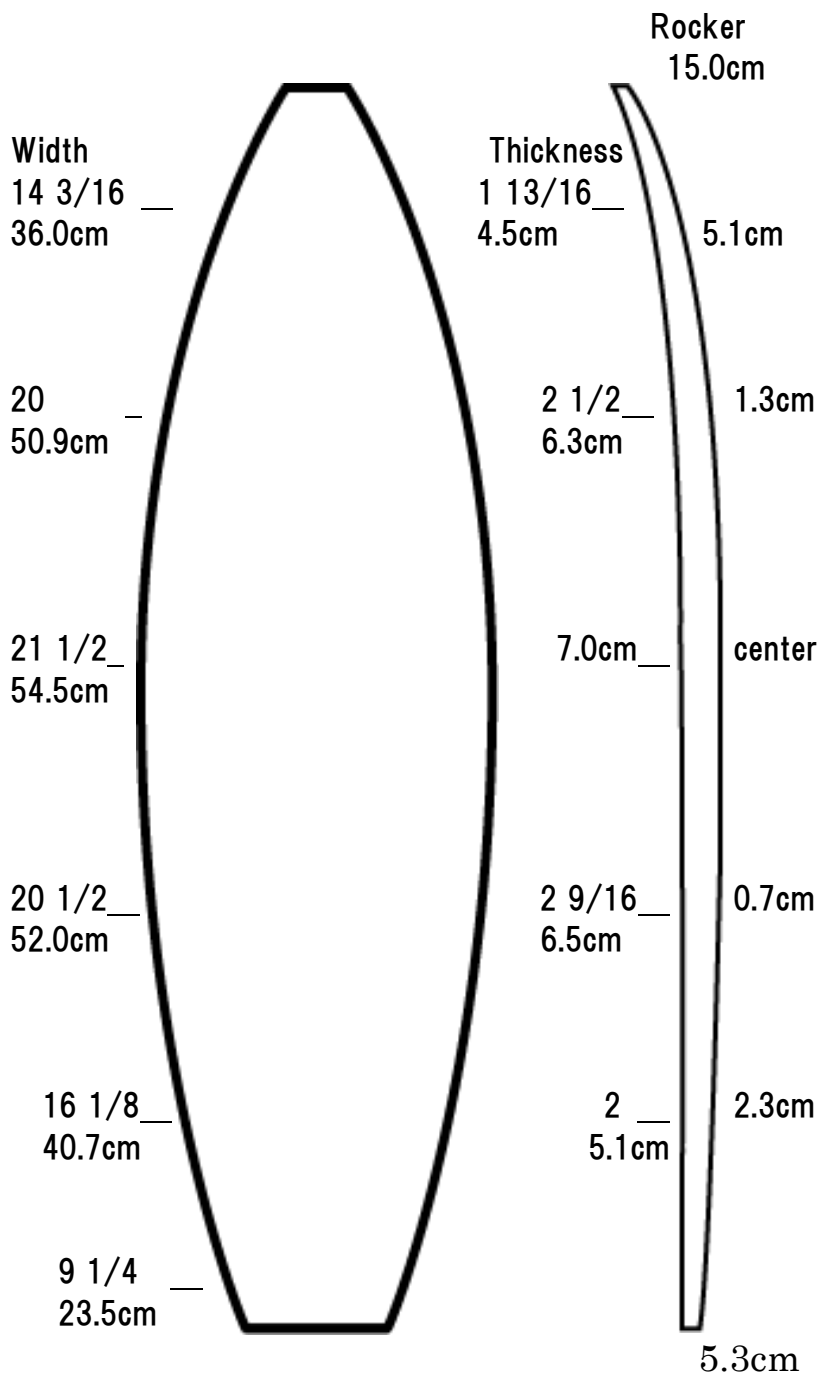

6'7"

D69

Actual Length	6'07" 202.1cm
Maximum Width	21 1/2 54.5cm
Maximum Thickness	7.0cm
History	1997
Rocker	D69
Weights	UL Team Rider
Stringer	1/8

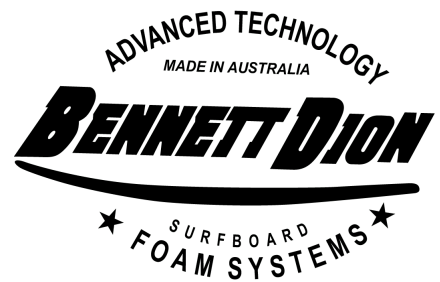

originally designed for profile machine cut nose flip kind curve

Bennett-Dion AUST.

6'7 Thick SPR rocker

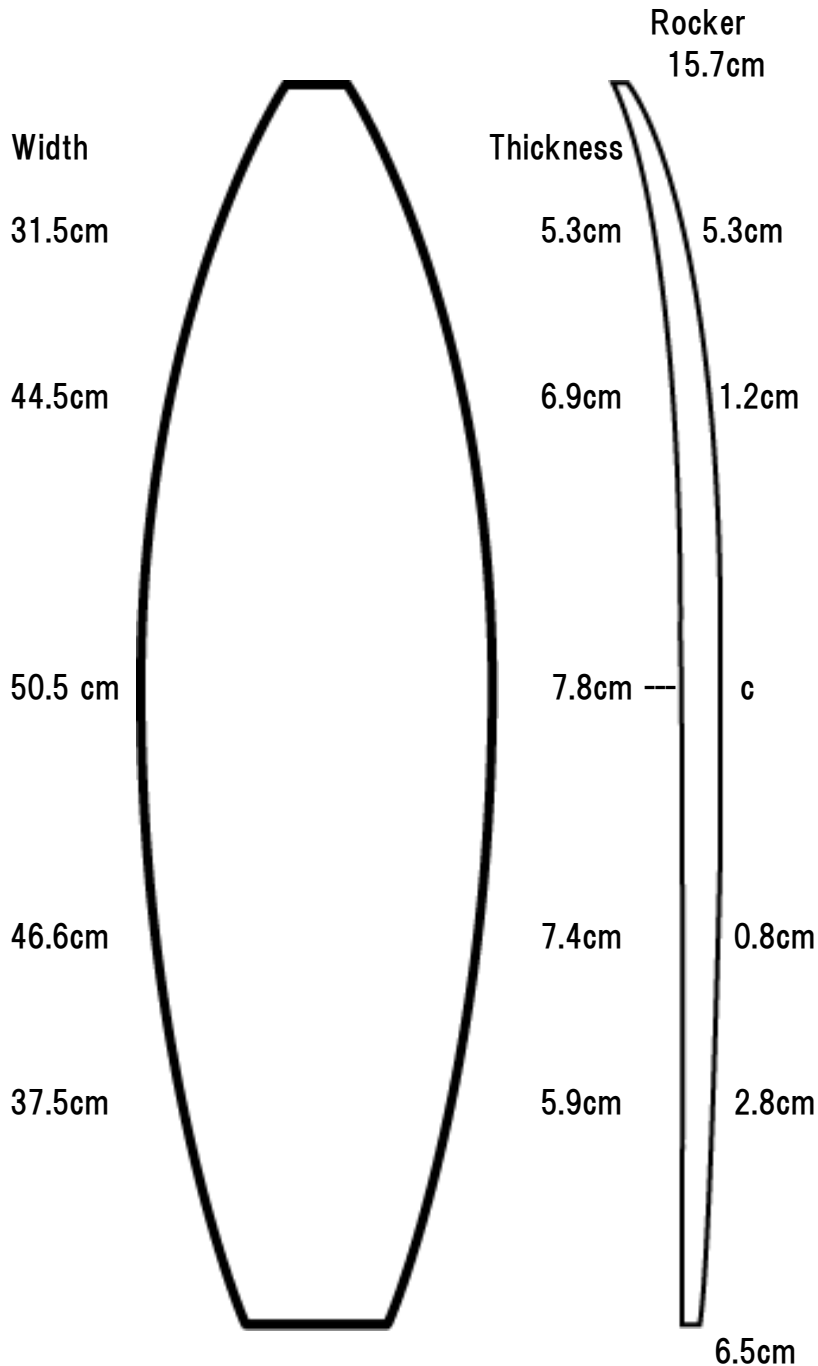

Actual Bottom Length	203cm
Max. Width	50.5cm
Max. Thickness	7.8cm
History	2014
Rocker	SPR
Weights	UL
Stringer	1/8

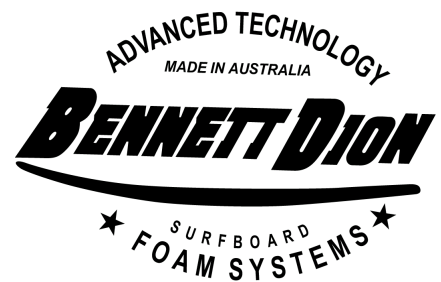

*Thicker version of 6'7
Suitable for both hand shaping and profile machine cut
Tail kick version of 6'7-D69 model*

Bennett-Dion AUST.

6'7 Thick D69 rocker

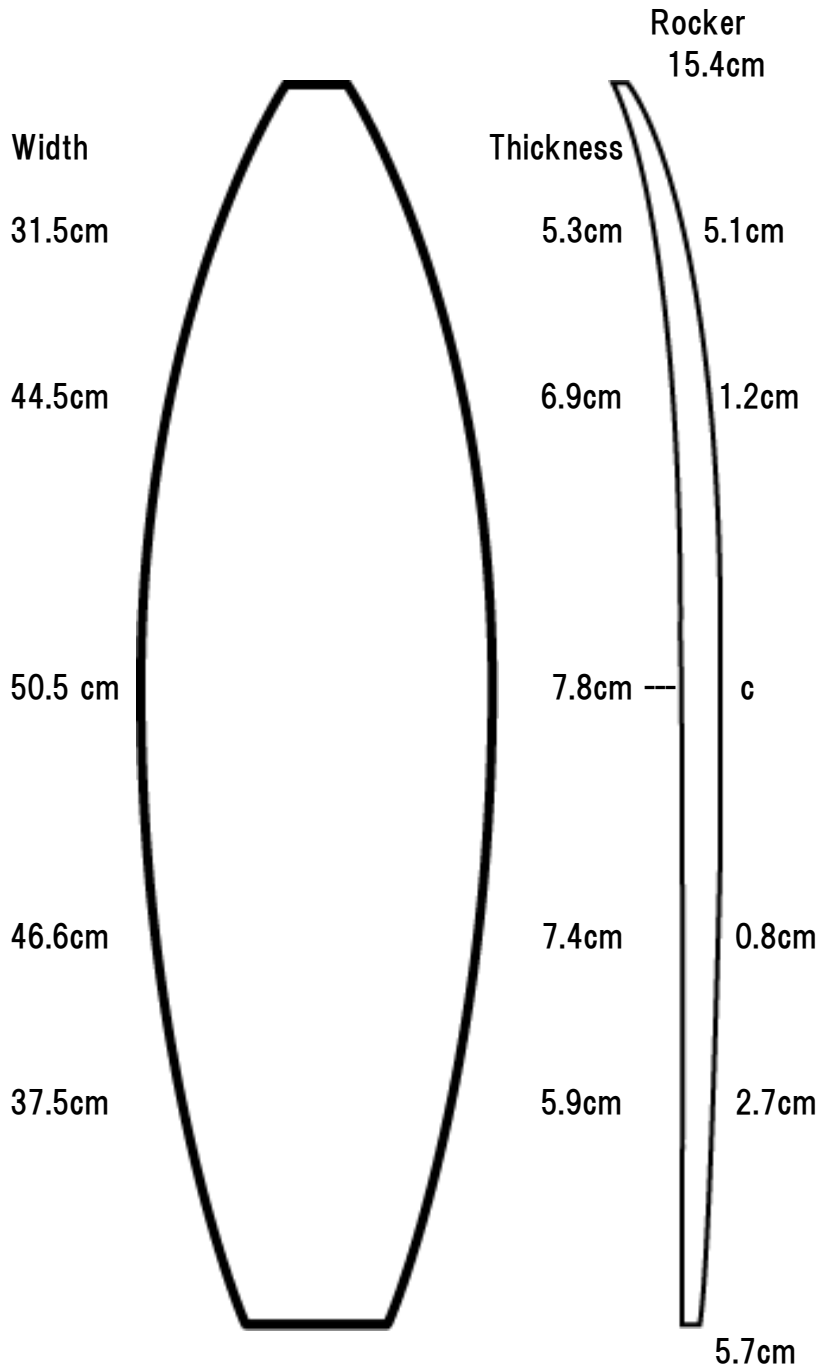

Actual Bottom Length	203cm
Max. Width	50.5cm
Max.Thickness	7.8cm
History	2014
Rocker	D69
Weights	UL
Stringer	1/8

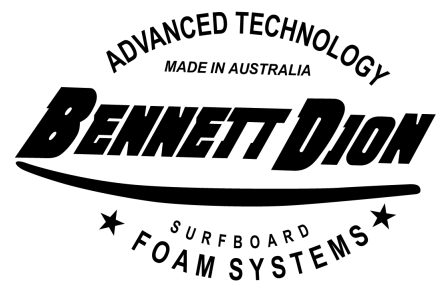

*Thicker version of 6'7
Suitable for both hand shaping and profile machine cut*

Bennett-Dion AUST.

6'10 Fat

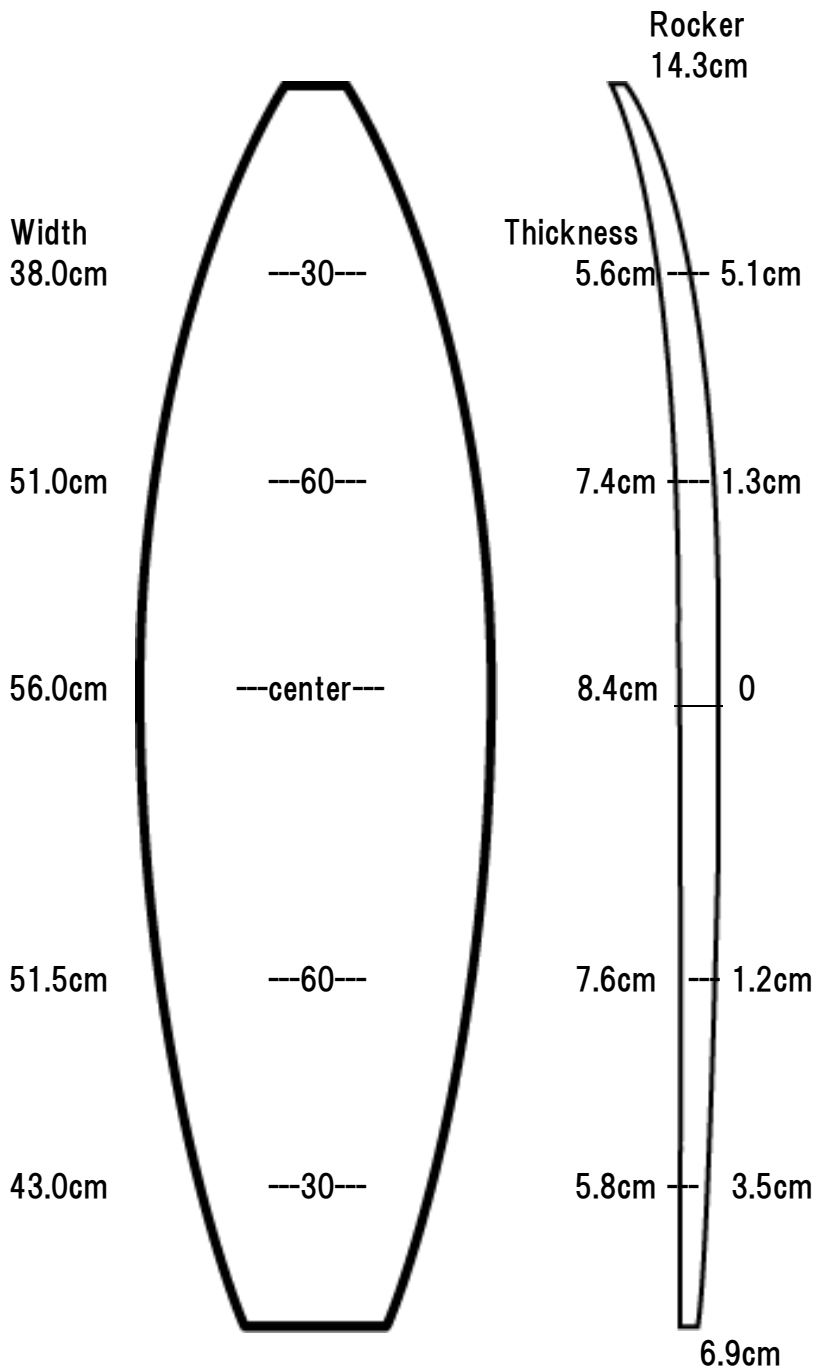

Actual Bottom Length	212.0 cm
Max.Width	56.0cm
Max.Thickness	8.4cm
History	2014
Rocker	D69
Weights	UL
Stringer	1/8

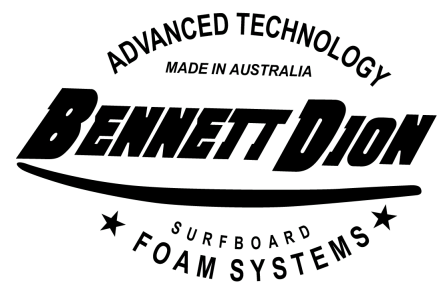

*数値はあくまで参考値

Bennett-Dion AUST.

7'2"

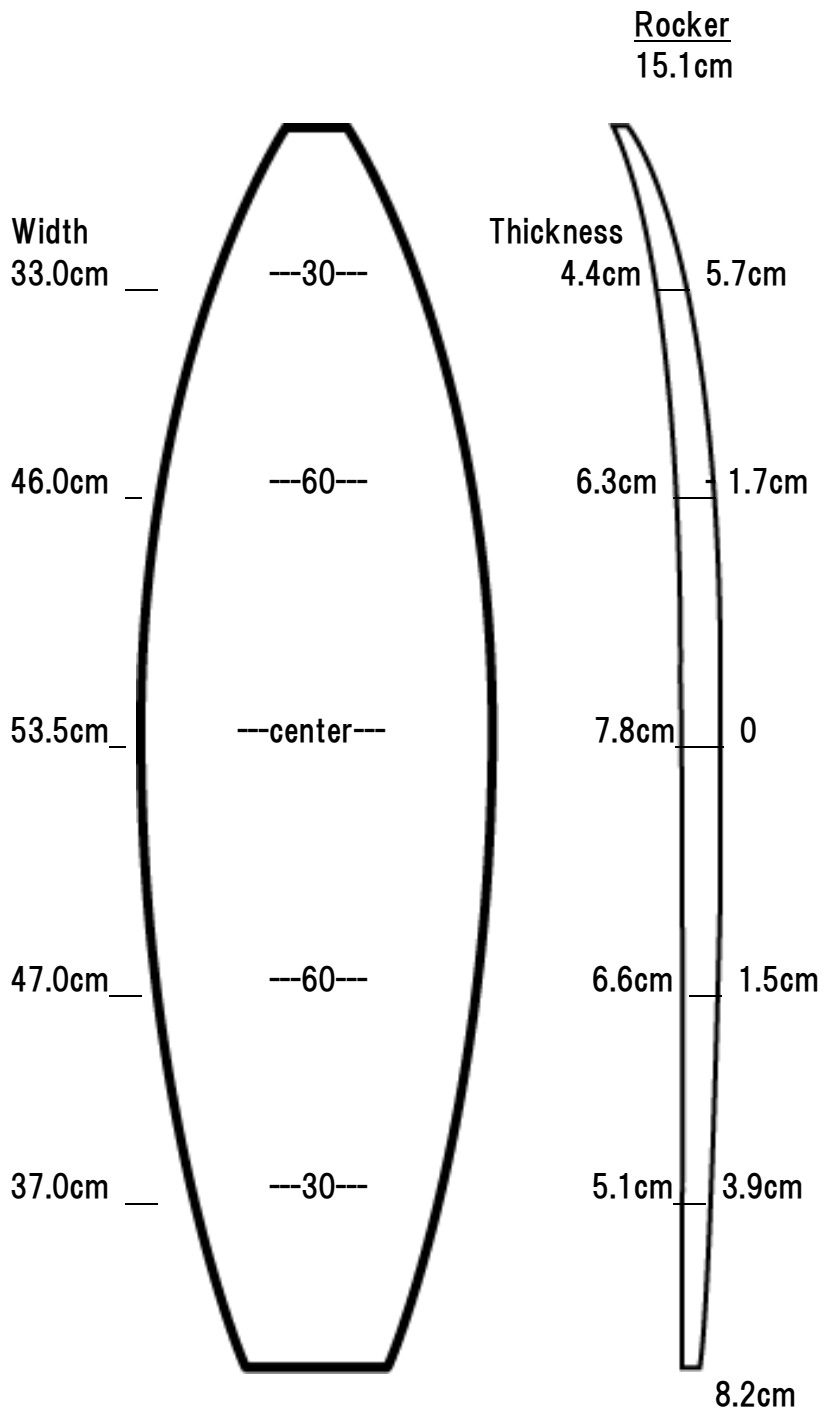

Actual Bottom Length	222.0cm
Max.Width	53.5cm
Max.Thickness	7.8cm
History	1998
Rocker	MOR
Weights	UL
Stringer	1/8

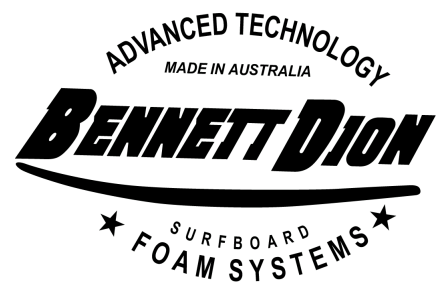

*数値はあくまで参考値

Bennett-Dion AUST.

Rocker
6' 1/2"

7'7"
D2

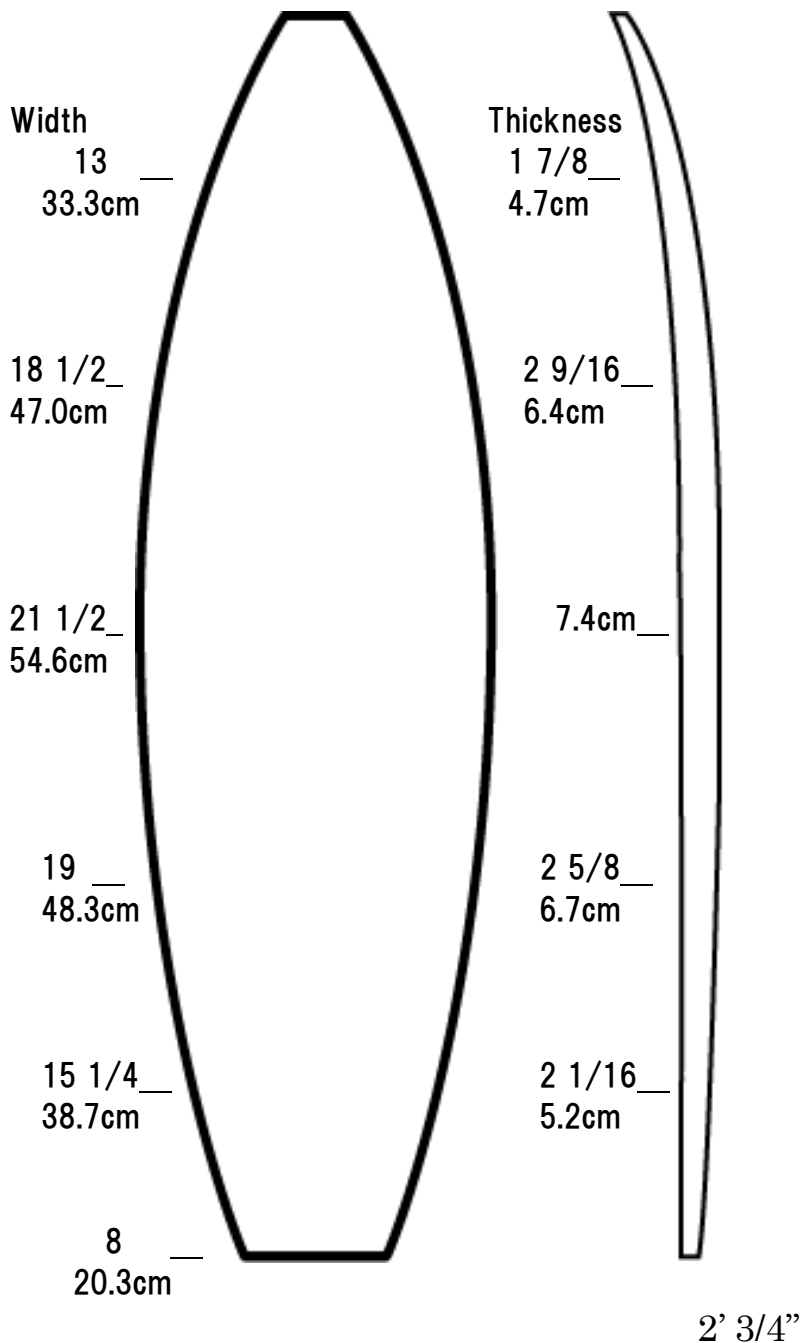

Actual Length	7'07" 231.4cm
Maximum Width	21 1/2 54.6cm
Maximum Thickness	7.4cm
History	1993
Rocker	D2
Weights	SSL
Stringer	

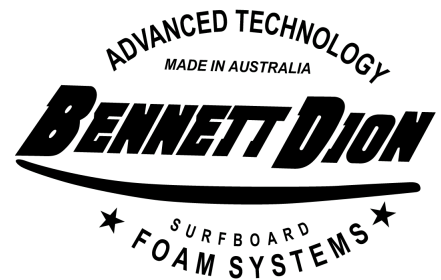

gun boards for bigger waves

Fish/Retro
Type

Bennett-Dion AUST.

Speed Shape Model

5'10"NBSS

Rocker 10.76cm

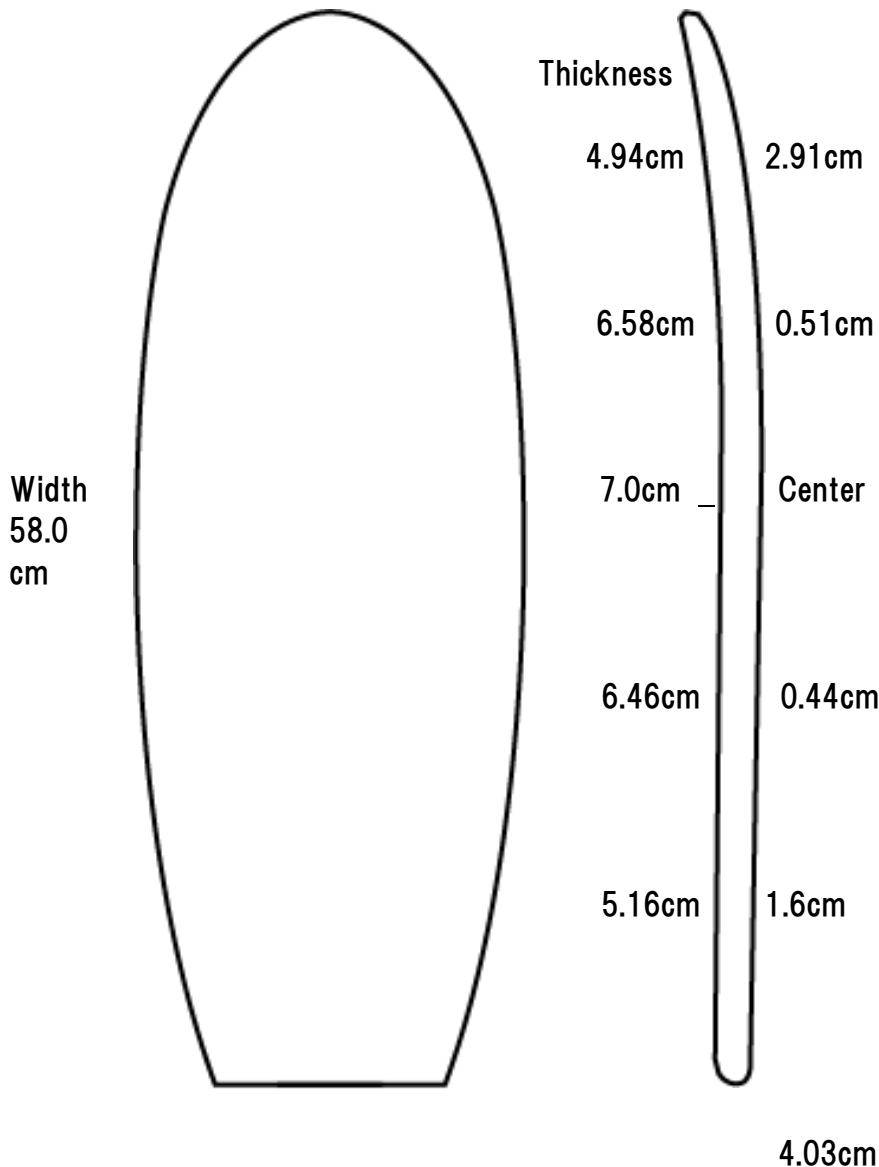

Deck Length	5'10"
Max. Width	-58.0cm
Max.Thickness	6.8 to 7.2cm
History	2016
Rocker	NB
Weights	UL
Stringer	1/8

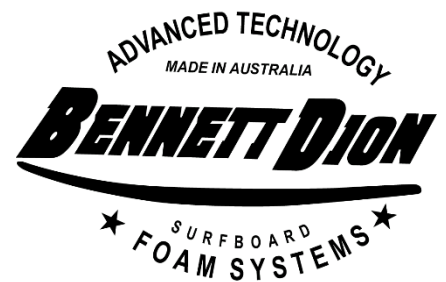

*データ数値はあくまで参考値

*アウトラインはカットされておりません (使用フォームによりアウトライン異なります)

*for retro or fish boards
small miniboards also suited*

Bennett-Dion AUST.

Speed Shape Model

Rocker 11.37cm

6'2"NBSS

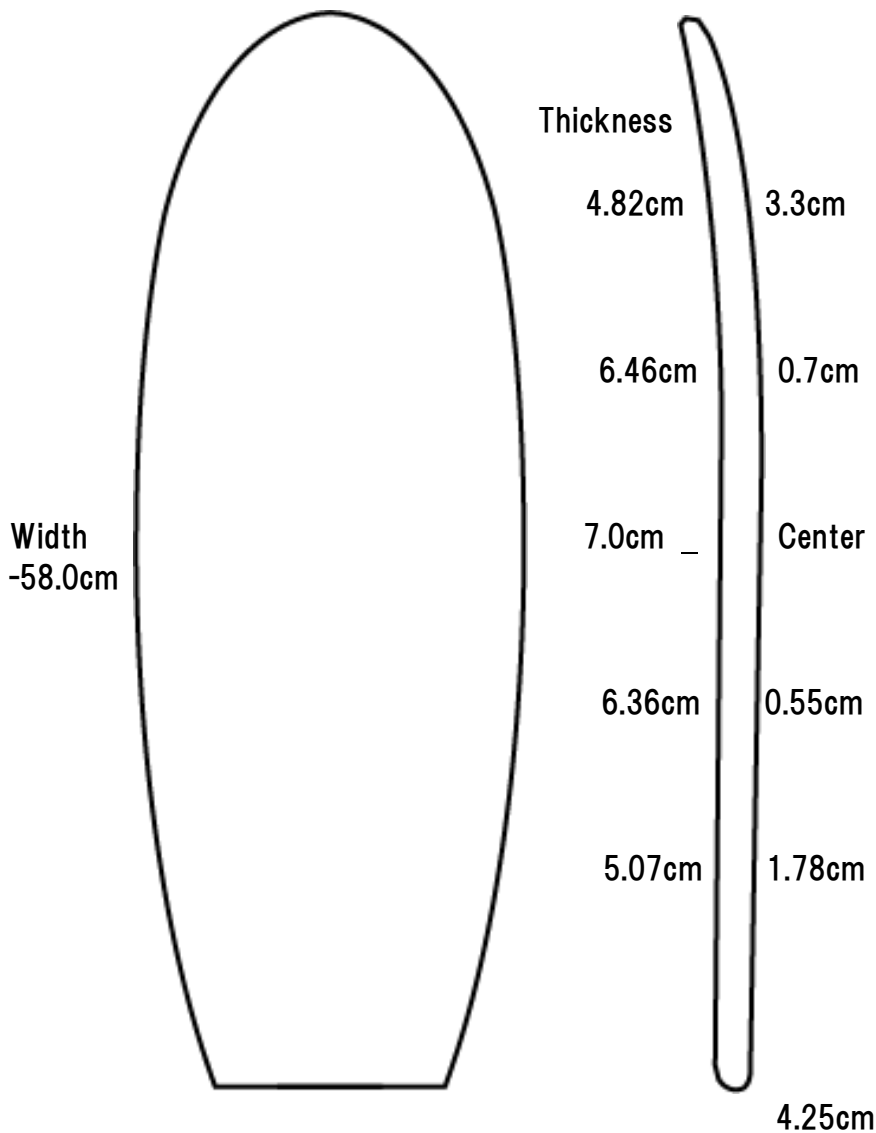

Deck Length	6'2"
Max. Width	58.0cm
Max.Thickness	6.8 to 7.2 cm
History	2016
Rocker	NB
Weights	UL
Stringer	1/8

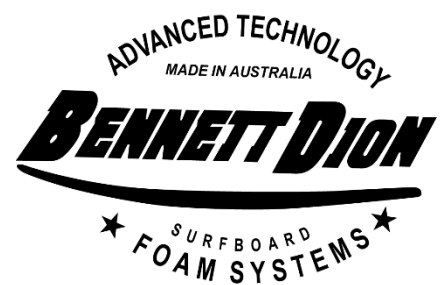

データ数値はあくまで参考値

*アウトラインはカットされておりません (使用フォームによりアウトライン異なります)

*for retro or fish boards
small minibboards also good*

Bennett-Dion AUST.

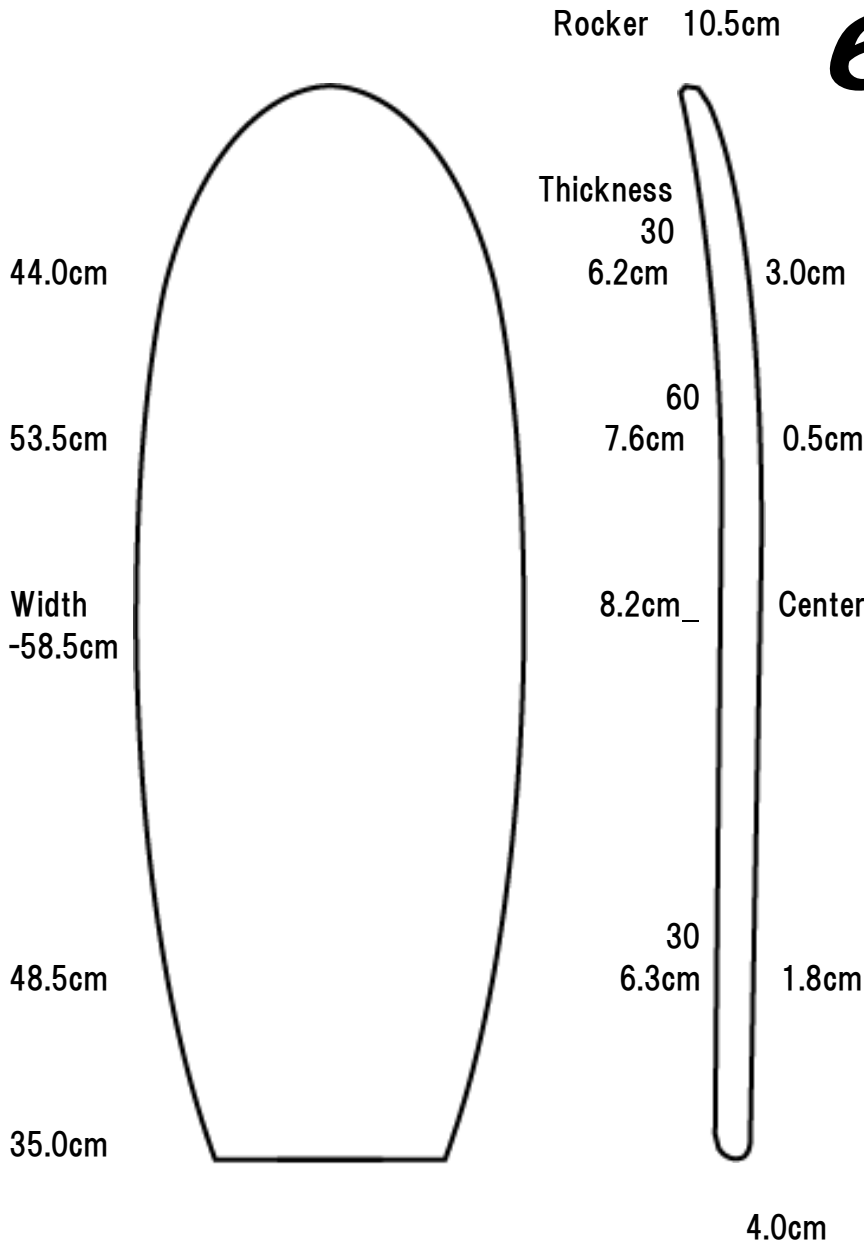

6'2" F

DDR rocker

Actual Length	6'2"
Max. Width	Under 58.5cm
Max.Thickness	8.2cm
History	2011
Rocker	DDR
Weights	SSL UL
Stringer	1/8

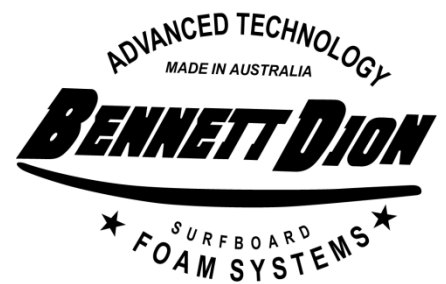

for retro or fish boards

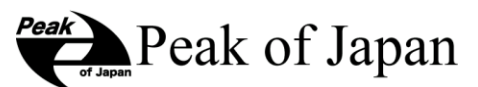

Bennett-Dion AUST.

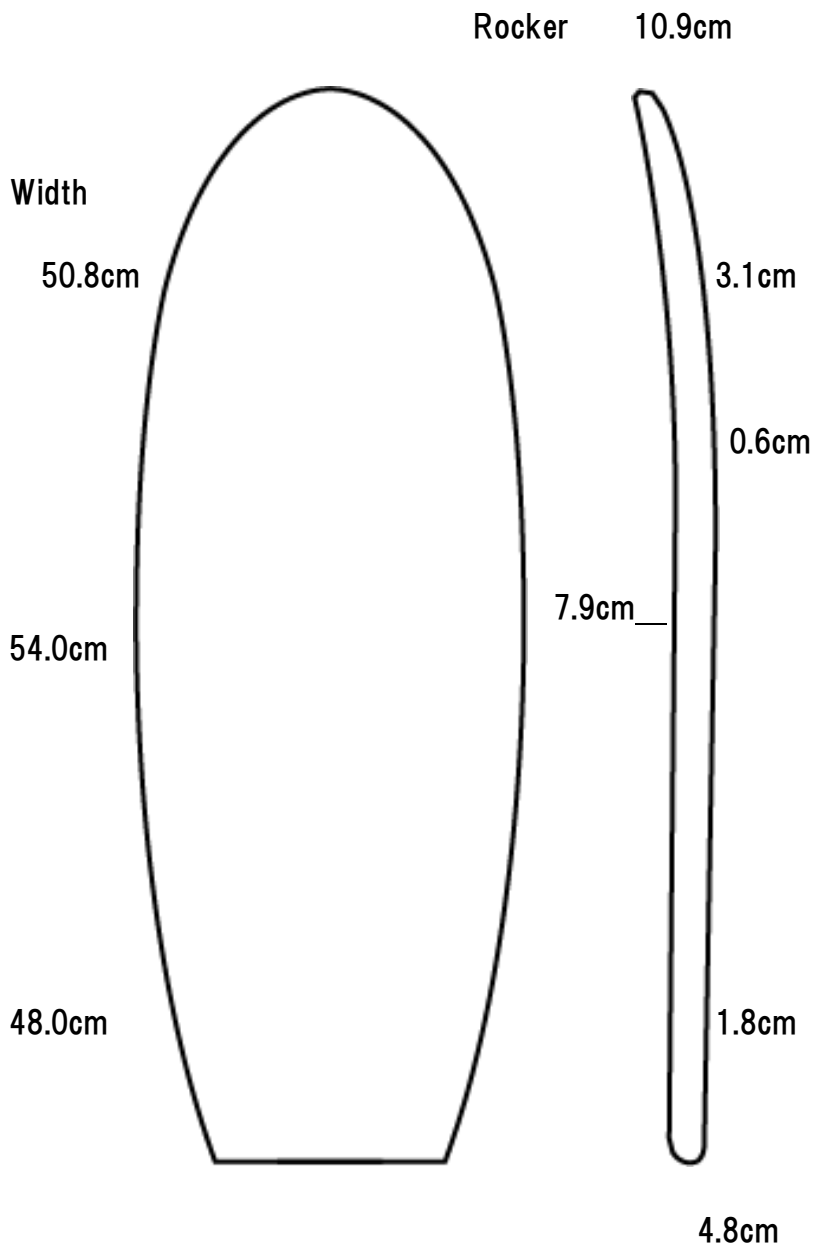

6'5"

KB5

Actual Length	6'05" 197cm
Maximum Width	60.3cm
Maximum Thickness	7.9cm
History	
Rocker	KB5
Weights	SSL
Stringer	1/8

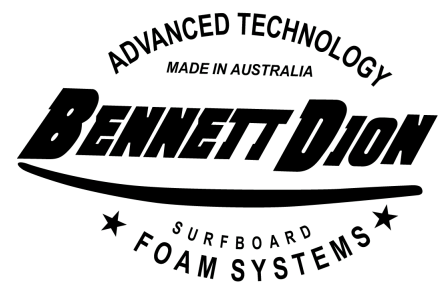

*originally designed for knee boards
versatile for fish/retro boards*

Bennett-Dion AUST.

6'9"

F5

Width
7 7/8 20.0cm

Rocker
11.4cm

18 13/16
47.8cm

Thickness
2 1/8
5.4cm

23 5/8
60.0cm

3 1/16
7.8cm

24 1/8
61.3cm

8.4cm

18 7/8
48.0cm

2 15/16
7.5cm

18 3/8
46.7cm

2 3/16
5.6cm

12 15/16 22.7cm

3.8cm

Actual Length	6'09" 207.5cm
Maximum Width	24 1/8 61.3cm
Maximum Thickness	8.4cm
History	Terry Martin & Hobie 2007
Rocker	F5
Weights	SSL
Stringer	

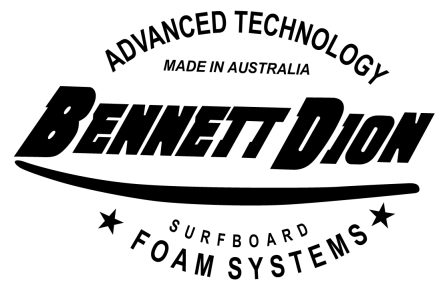

*for retro or fish boards
low, natural curve*

Bennett-Dion AUST.

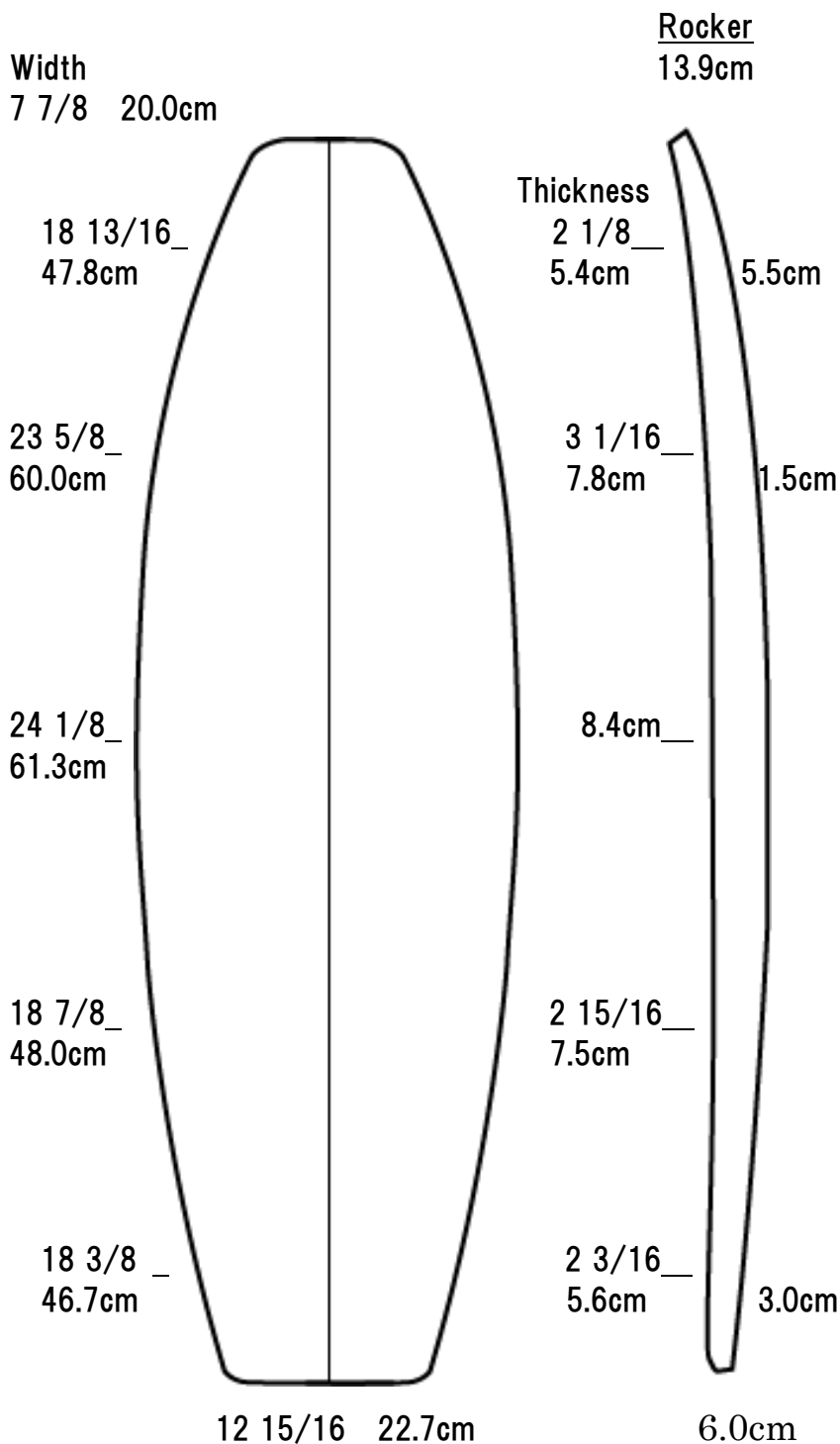

6'9"

F2 Rocker

Actual Length	6'09" 207.5cm
Maximum Width	24 1/8 61.3cm
Maximum Thickness	8.4cm
History	Terry Martin & Hobie 2007
Rocker	F2
Weights	
Stringer	

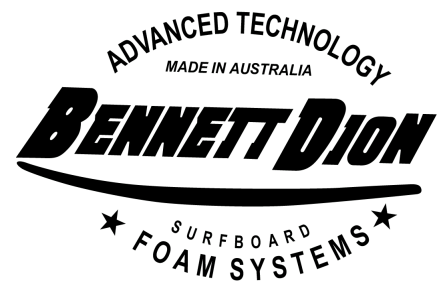

*for retro or fish boards
curvy rocker*

Funboard Type

Bennett-Dion AUST.

Speed Shape Model

Rocker
10.6cm

7'3MMss

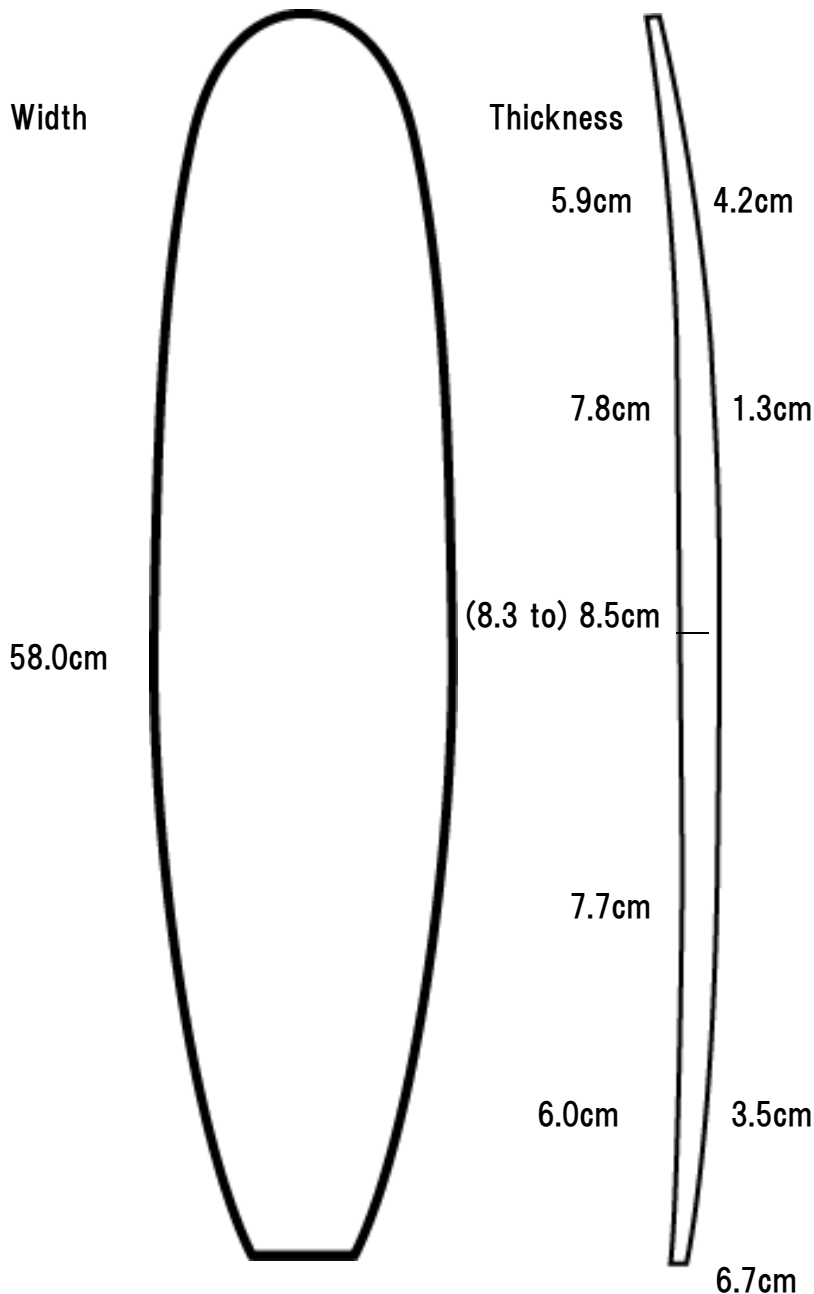

Actual Length	223.0cm
Max.Width	58.00cm
Max.Thickness	8.3 to 8.5cm
History	2013
Rocker	
Weights	SSL
Stringer	1/4

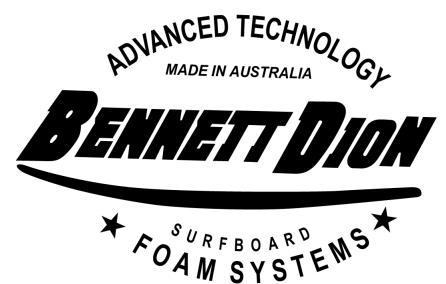

Bennett-Dion AUST.

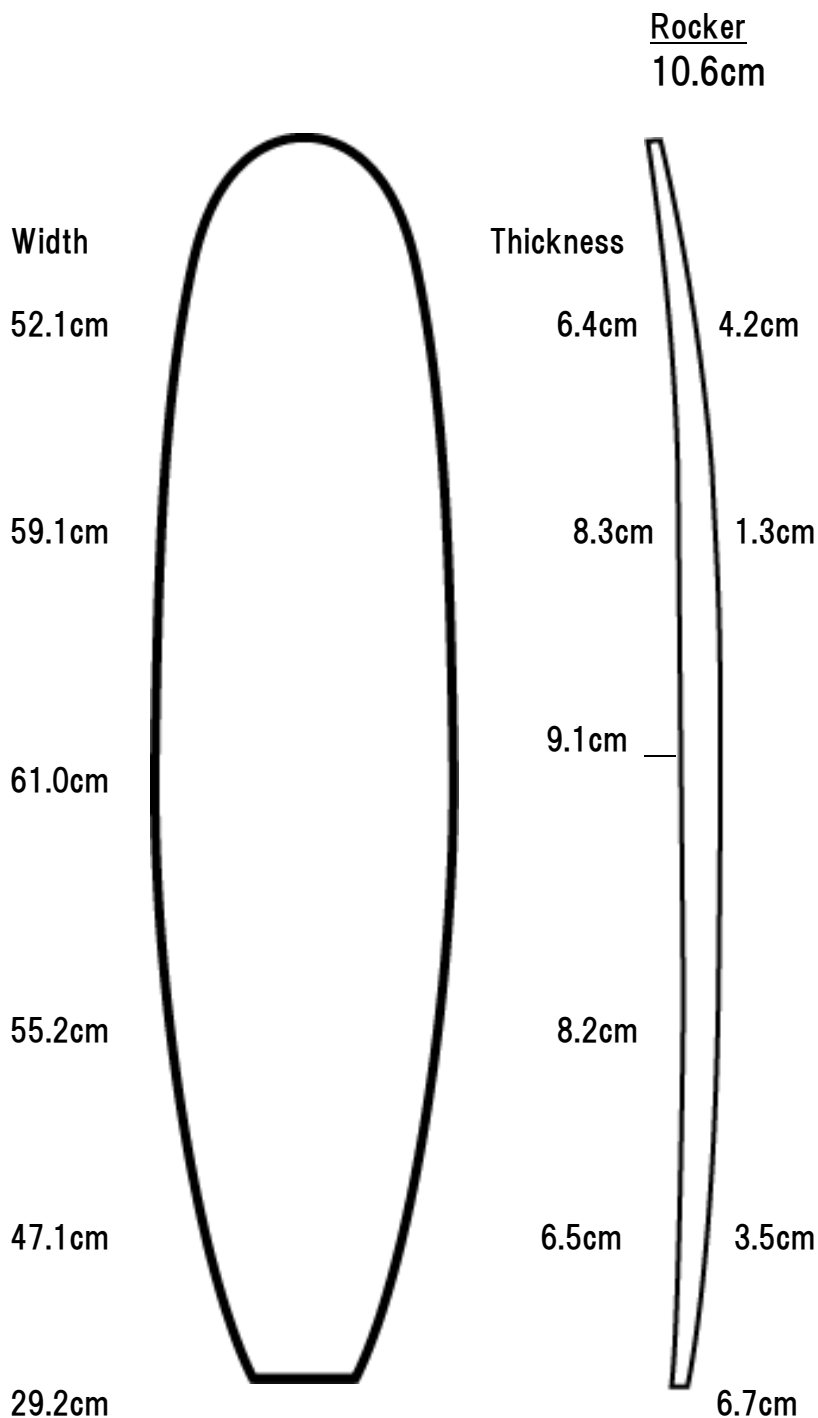

7'3mm **MM21 Rocker**

Actual Length	7'03" 222.0cm
Max.Width	61.00cm
Max.Thickness	9.1cm
History	2011 NEW
Rocker	MM21
Weights	SSL
Stringer	1/4

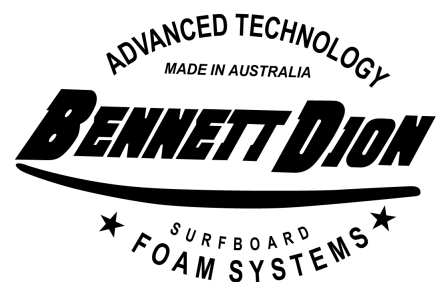

This newly made 7'3 is thicker and wider all over than the original, ideal for small mini mals, retro fun shapes, big guy fishes or single fins and mini-longs. Will suit a wide range of rockers and be easy to machine and hand shape.

Bennett-Dion AUST.

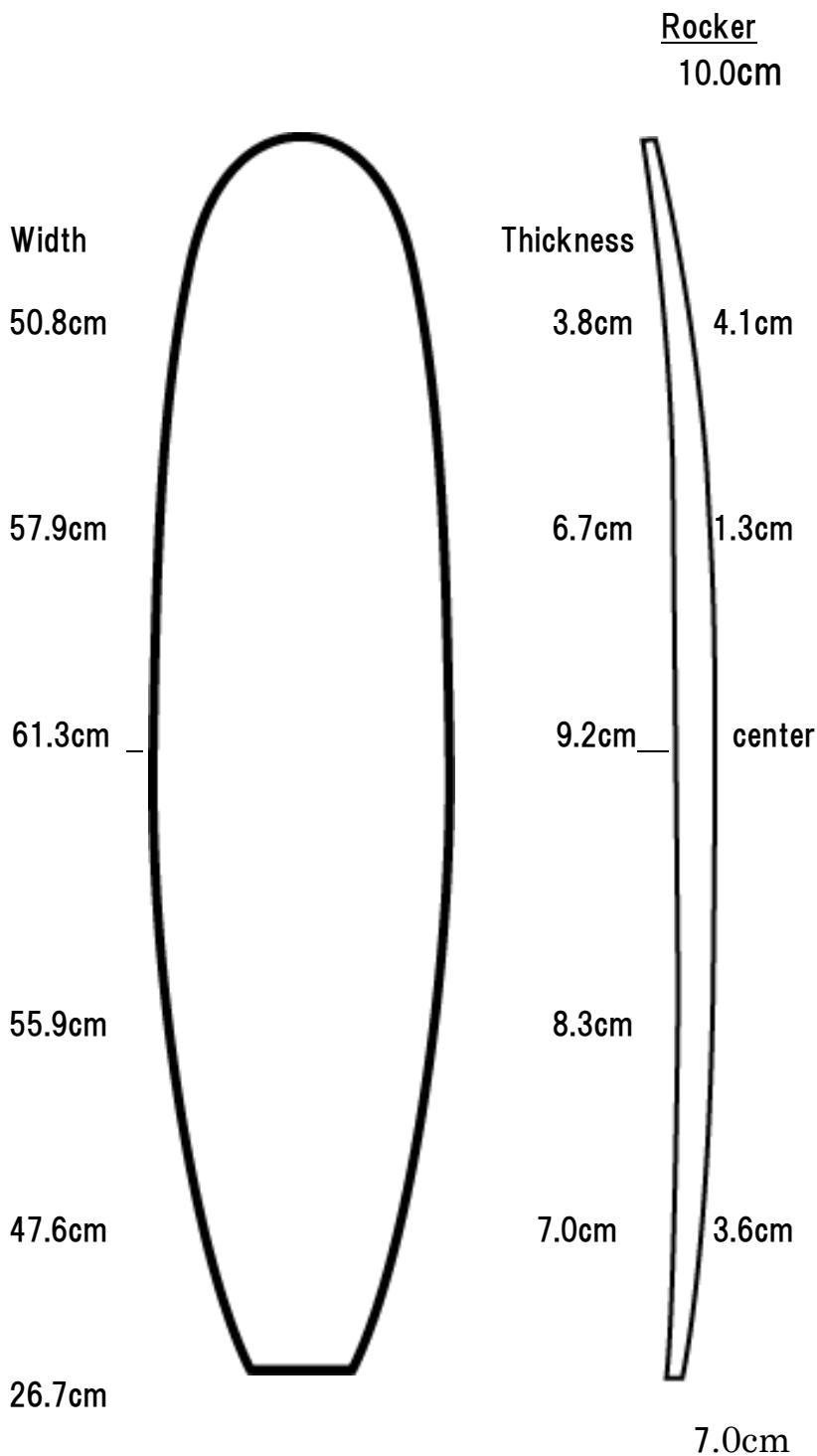

7'7mm
MM21 Rocker

Actual Length	7'07" 1/4 234.69cm
Max.Width	61.60cm
Max.Thickness	9.2cm
History	2011 NEW
Rocker	MM21
Weights	SSL
Stringer	1/4

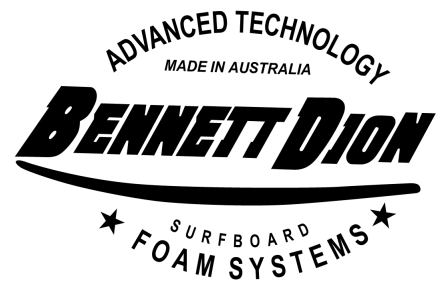

Based on the original 7'7 Mini Mal with added width and thickness throughout. Will suit a wider range of plan shapes and rocker templates for mini mals, big guy fun shapes, large fish, retro shapes and mini longs. Ideal to either machine or hand shape.

Bennett-Dion AUST.

8'4"

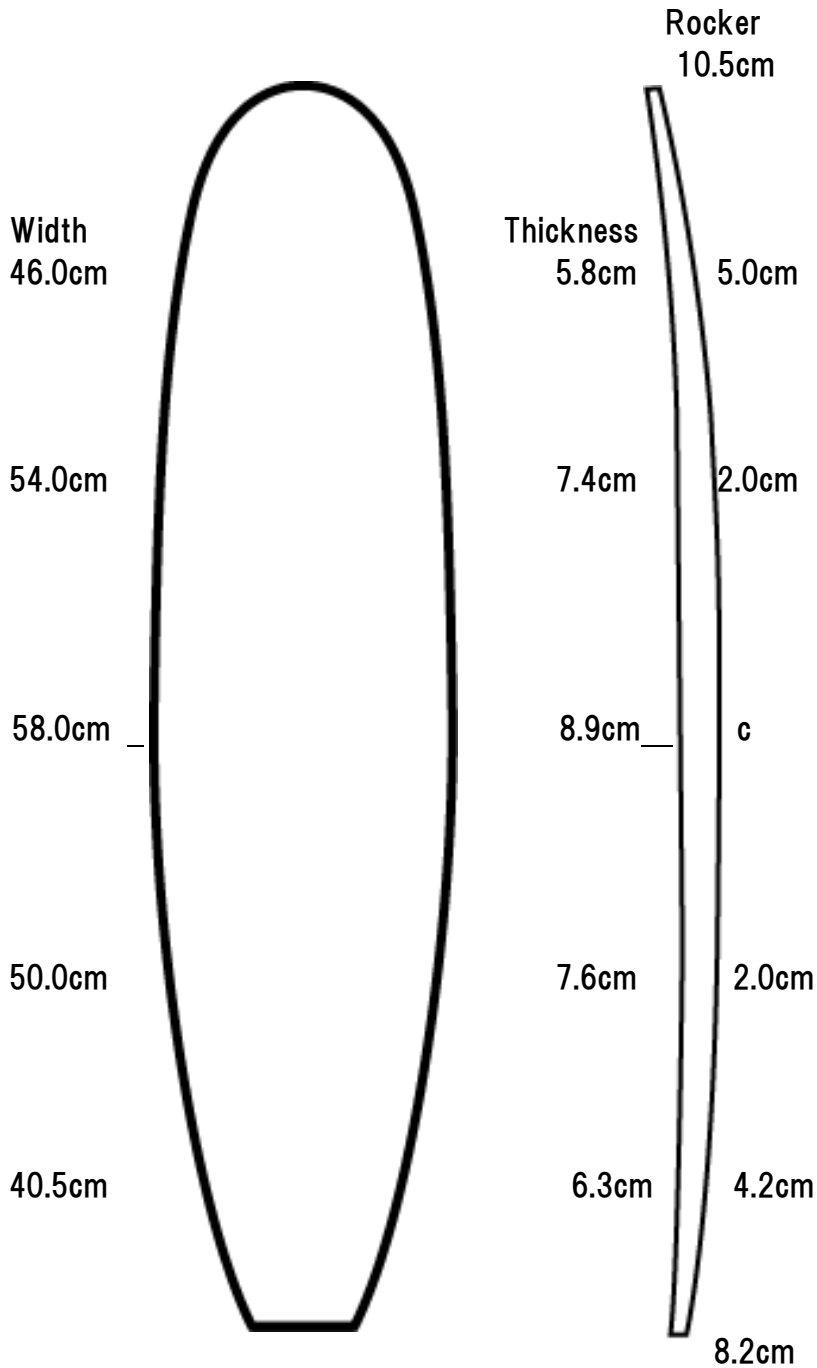

Actual Bottom Length	256.5cm
Max. Width	58.0cm
Max.Thickness	8.9cm
History	2015
Rocker	SKMZ
Weights	SSL
Stringer	1/4 Redwood Multi stringer

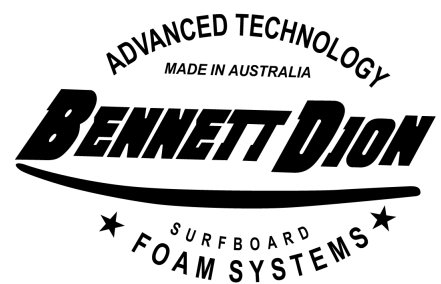

*数値はあくまで目安参考値

Longboard
Type

Bennett-Dion AUST.

Speed Shape Model

9'2"ss

Performance

Model

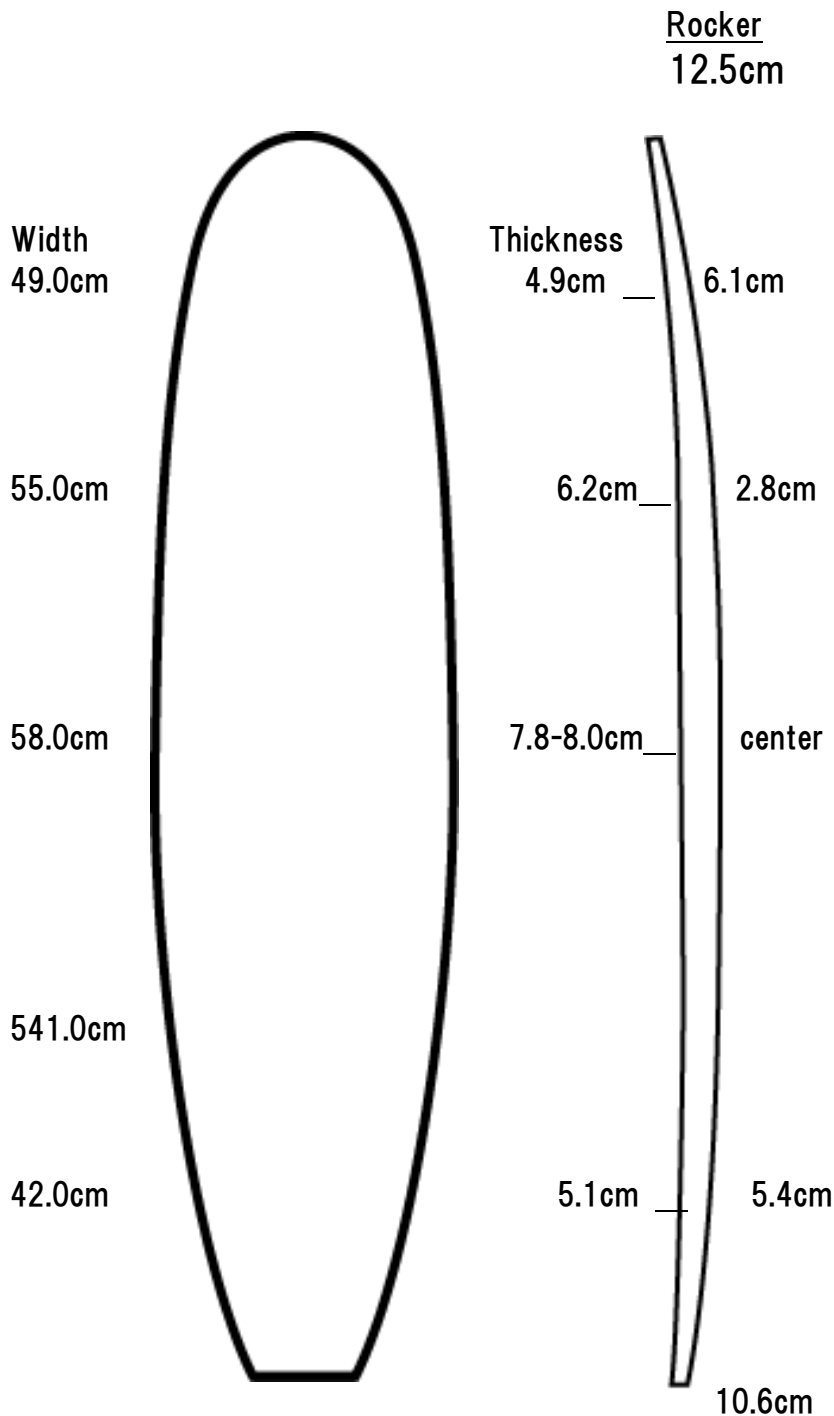

Actual Length	9'2"
Max. Width	Under 58.0cm
Max.Thickness	7.8-8.0cm
History	2009
Rocker	SS
Weights	SSL UL TP
Stringer	1/4

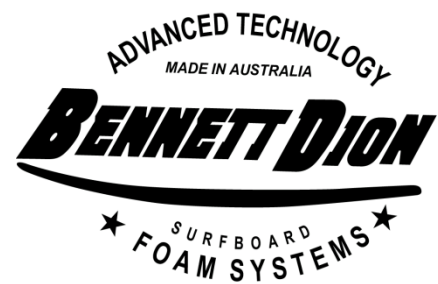

データ数値 個体差あり

high performance model, tail flip

Bennett-Dion AUSTRALIA

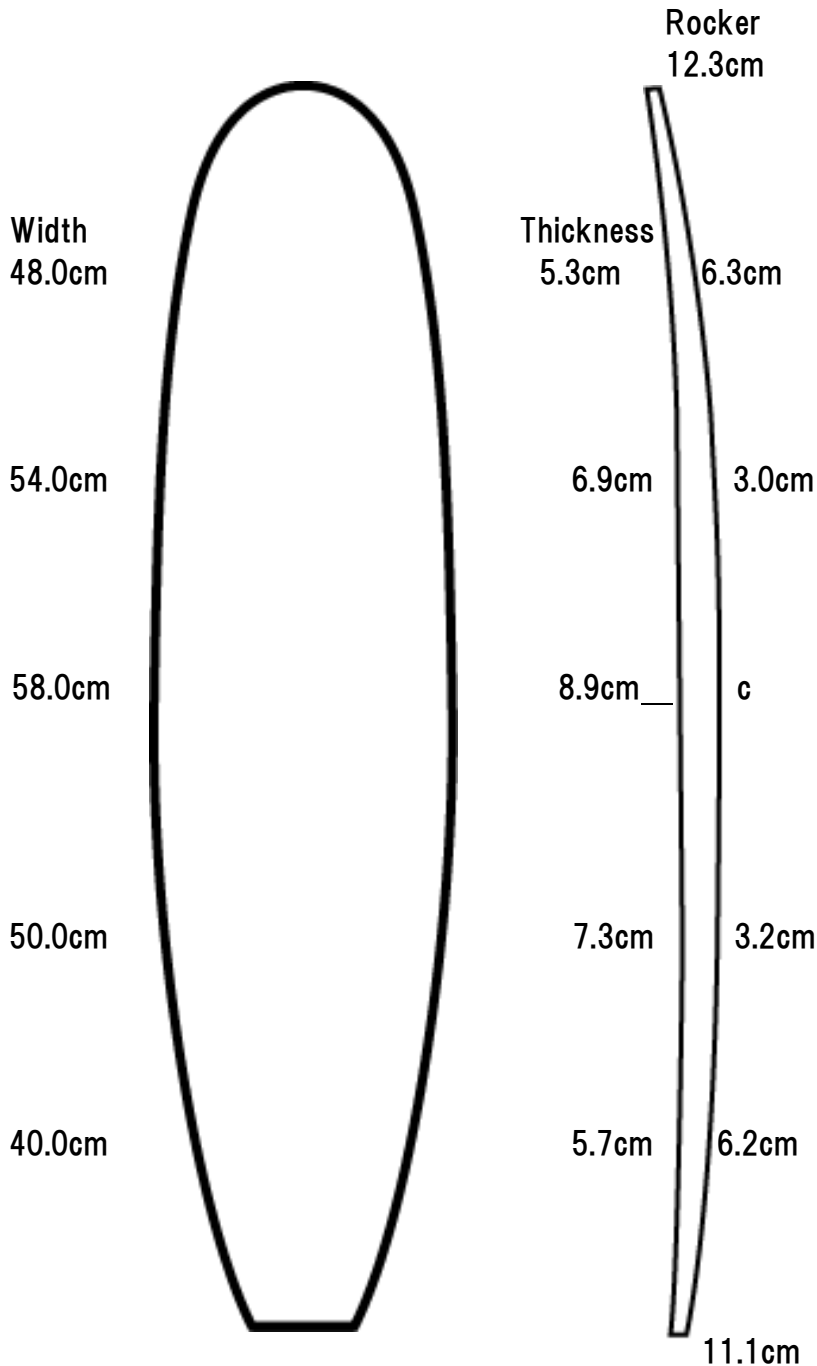

9'6

performance

Actual Bottom Length	292.5cm
Max. Width	58.0cm
Max.Thickness	8.9cm
History	2015
Rocker	V1 performance
Weight	Normal
Stringer Variation	

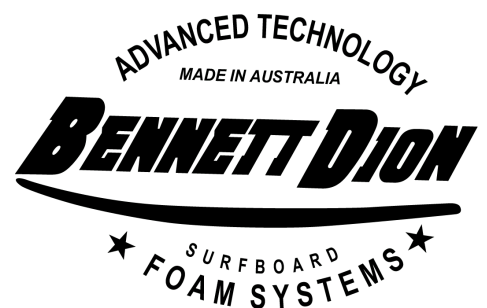

Newly re-designed curve named as V1, suitable for the latest modern performance design

*数値はあくまで目安参考値

Bennett-Dion AUSTRALIA

9'6 AR2

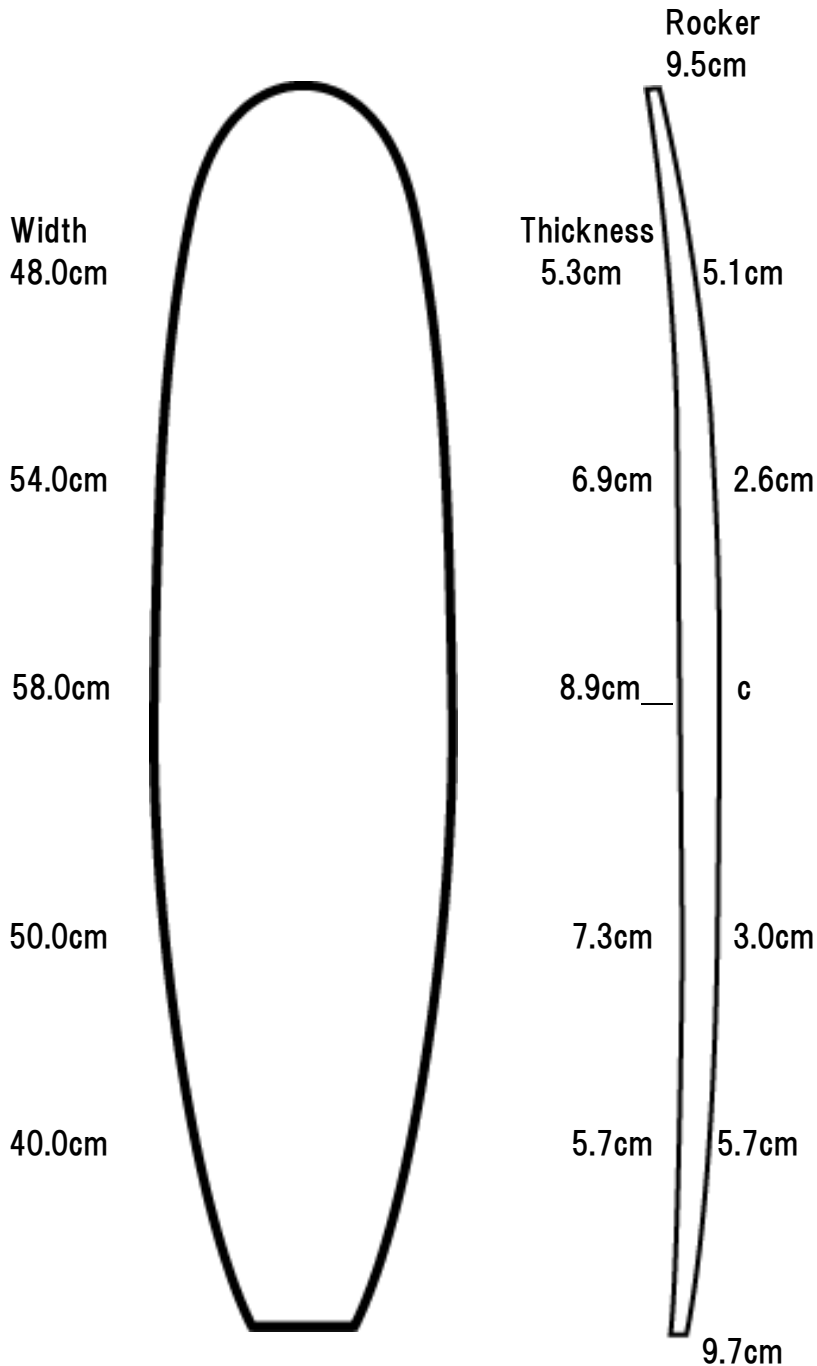

Actual Bottom Length	292.5cm
Max. Width	58.0cm
Max.Thickness	8.9cm
History	2016
Rocker	AR2
Weight	Normal
Stringer Variation	

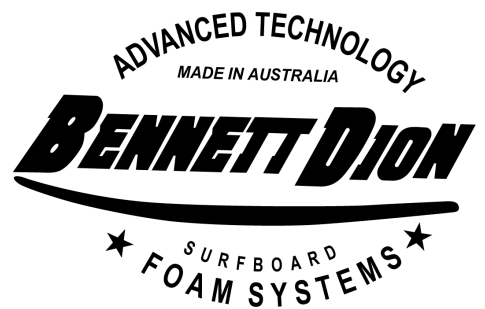

Newly re-designed curve for all round design through classic

*数値はあくまで目安参考値

Bennett-Dion AUSTRALIA

9'8 CL3

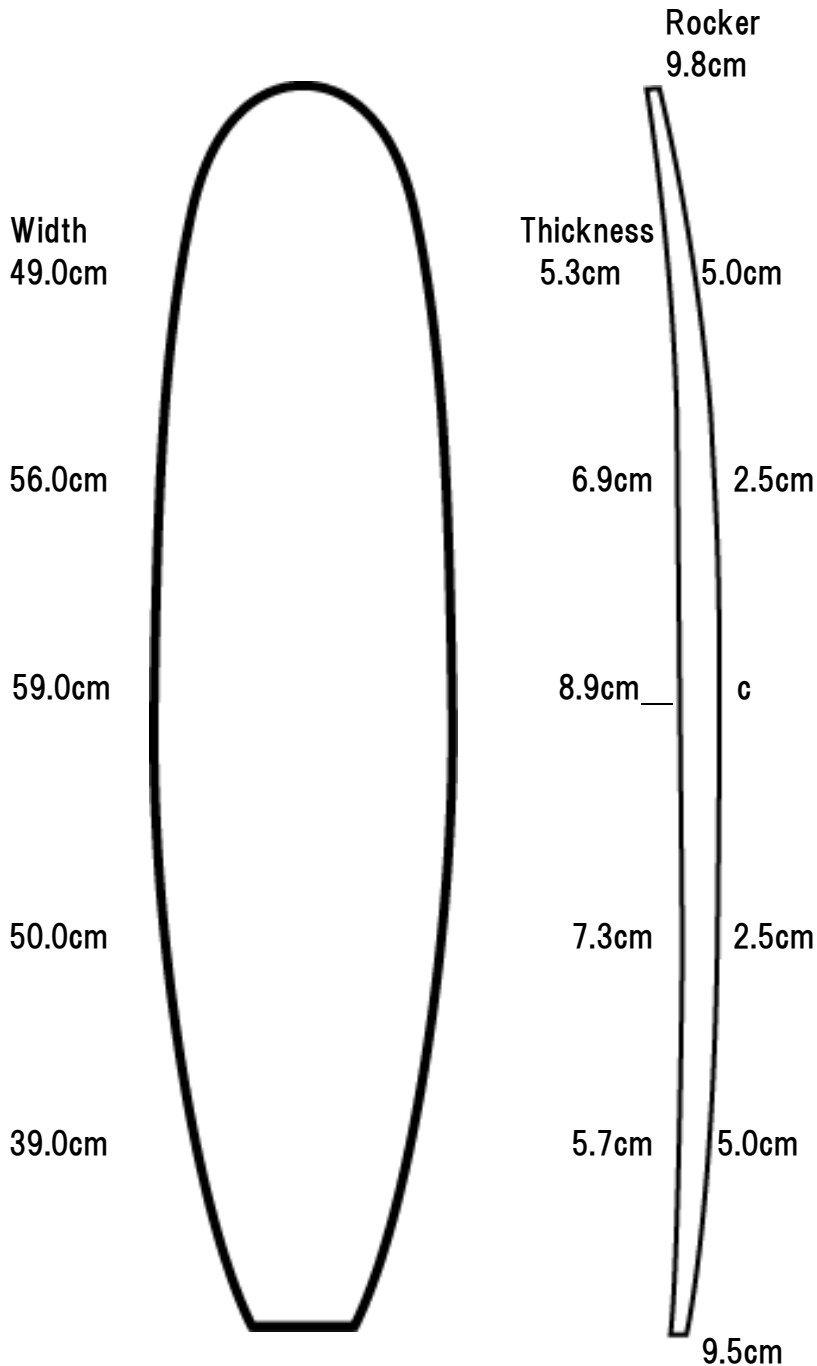

Actual Bottom Length	296.0cm
Max. Width	59.0cm
Max.Thickness	8.9cm
History	2016
Rocker	CL3
Weight	Normal
Stringer Variation	Redwood Balsa 2stringer 3stringer 4 stringer etc.

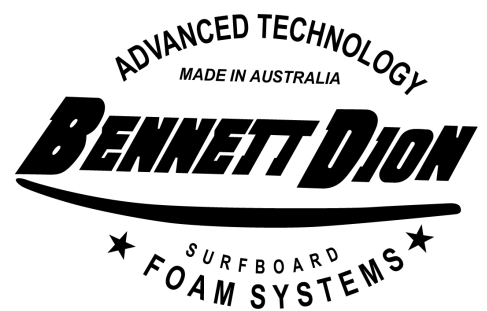

Newly re-designed curve for all classic design, latest or old school or whatever...

*数値はあくまで目安参考値

Bennett-Dion AUST.

10'2"

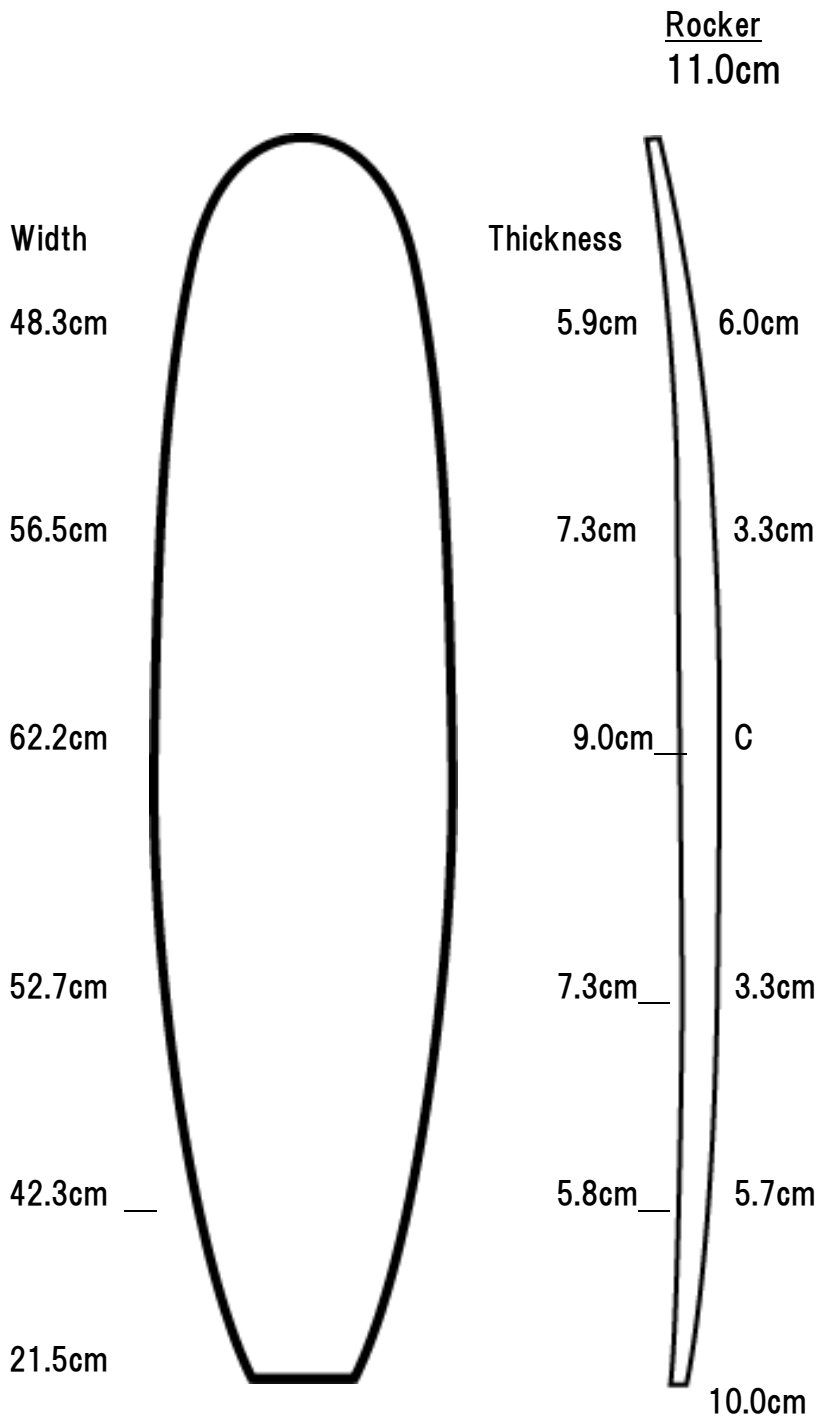

Actual Bottom Length	312.0cm
Max Width	62.2cm
Max Thickness	9.0cm
History	2014
Rocker	BB
Weights	SSL
Stringer	

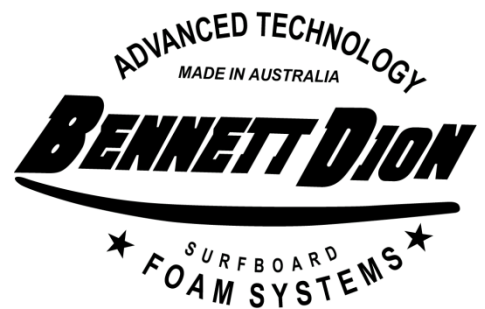

数値はあくまで目安参考値

EPSS

Bennett-Dion EPS Foam System

EPS 6'7 DD

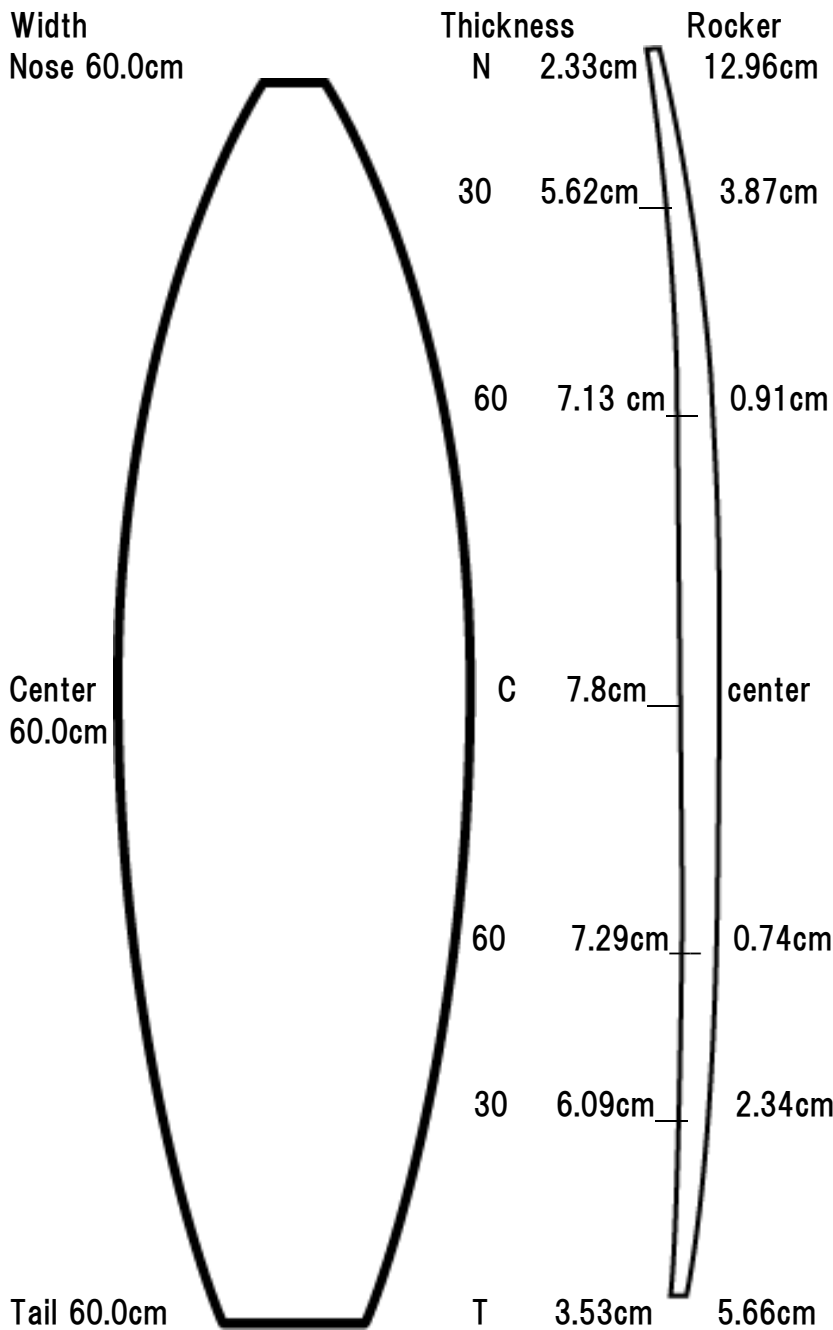

Deck Length	201cm
Max. Width	60.0cm
Max.Thickness	7.8cm
History	2016
Rocker	DD
Weights	x40 · x 30
Stringer	1/8 No stringer

*数値はあくまで参考値

Bennett-Dion EPS Foam System

EPS 6'7 FR

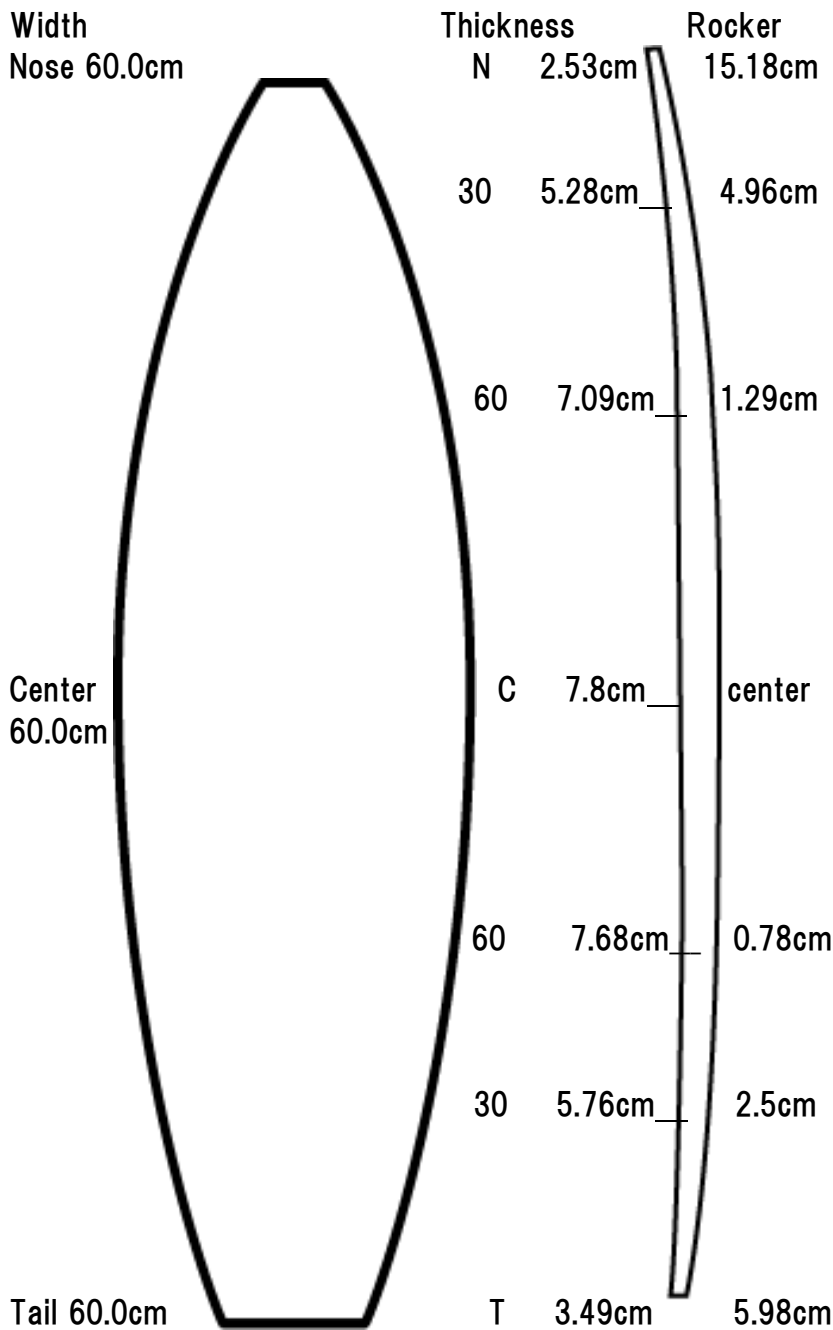

Deck Length	201cm
Max. Width	60.0cm
Max.Thickness	7.8cm
History	2016
Rocker	FR
Weights	x40 · x30
Stringer	1/8 No stringer

*数値はあくまで参考値

Bennett-Dion EPS

EPS 9'4

V1 Performance

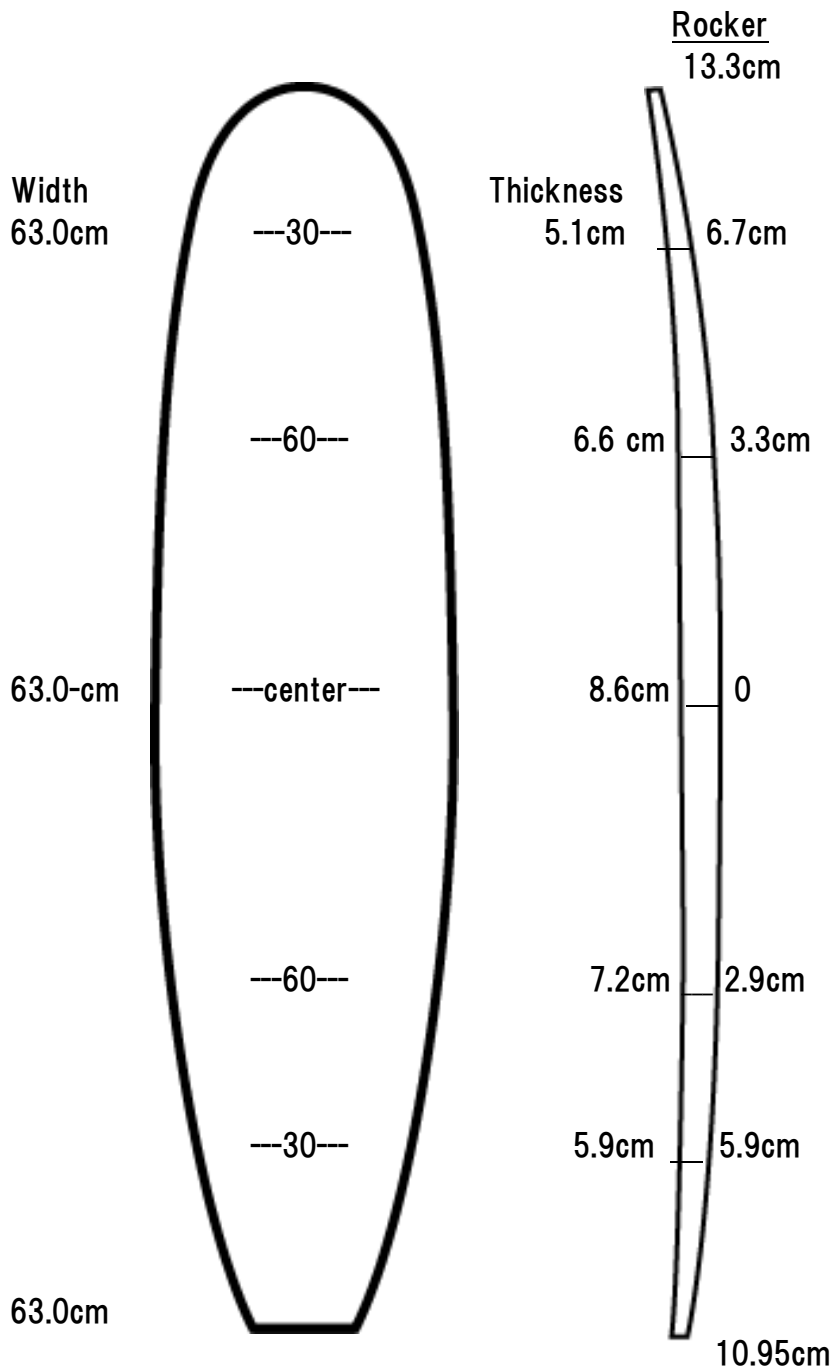

Actual Length	Deck	285.0cm
		9'4"
Max. Width		63.0cm
Max.Thickness		8.6cm
		Extra Fat
History		2018
Rocker		V1
Weight		normal
Stringer		ASK

* 数値はあくまで目安の参考値

Bennett-Dion EPS

EPS 9'4

V2 all-round

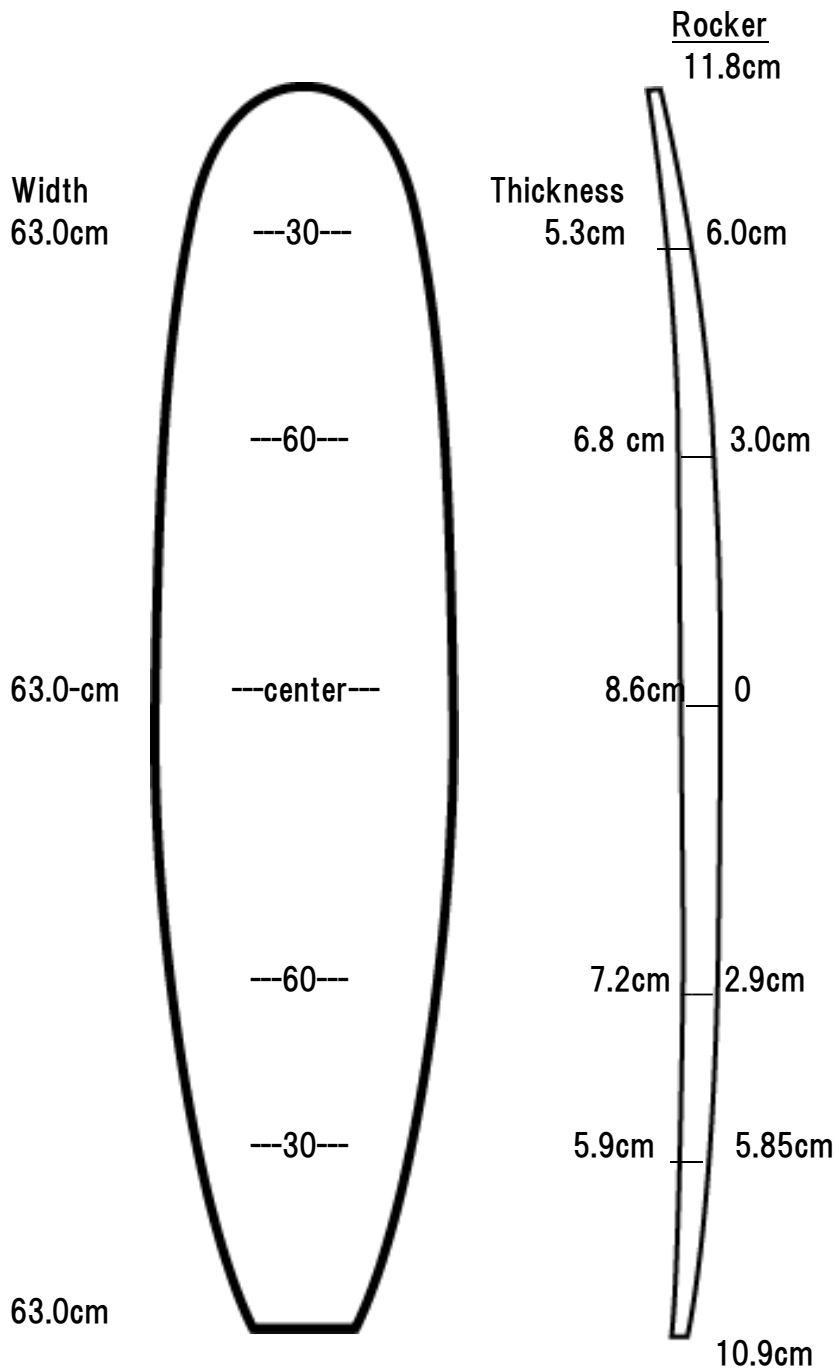

Actual Length	Deck	285.0cm
		9'4"
Max. Width		63.0cm
Max.Thickness		8.6cm
		Extra Fat
History		2018
Rocker		V2
Weight		normal
Stringer		ASK

* 数値はあくまで目安の参考値

Bennett-Dion EPS

EPS 9'4

V3 classic

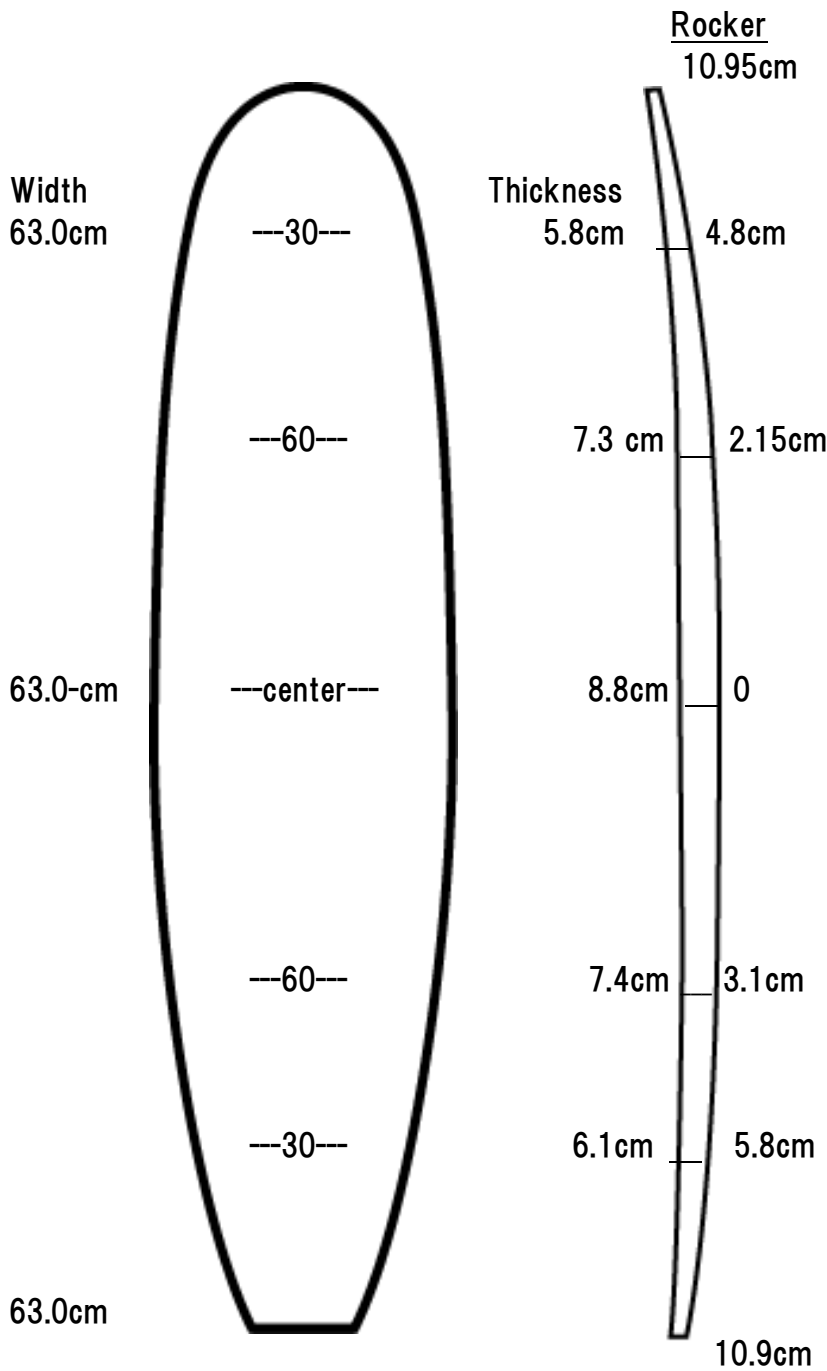

Actual Length	Deck	285.0cm
		9'4"
Max. Width		63.0cm
Max.Thickness		8.8cm
		Extra fat
History		2019
Rocker		V3
Weight		normal
Stringer		ASK

* 数値はあくまで目安の参考値

EPS

EPS 10'1''

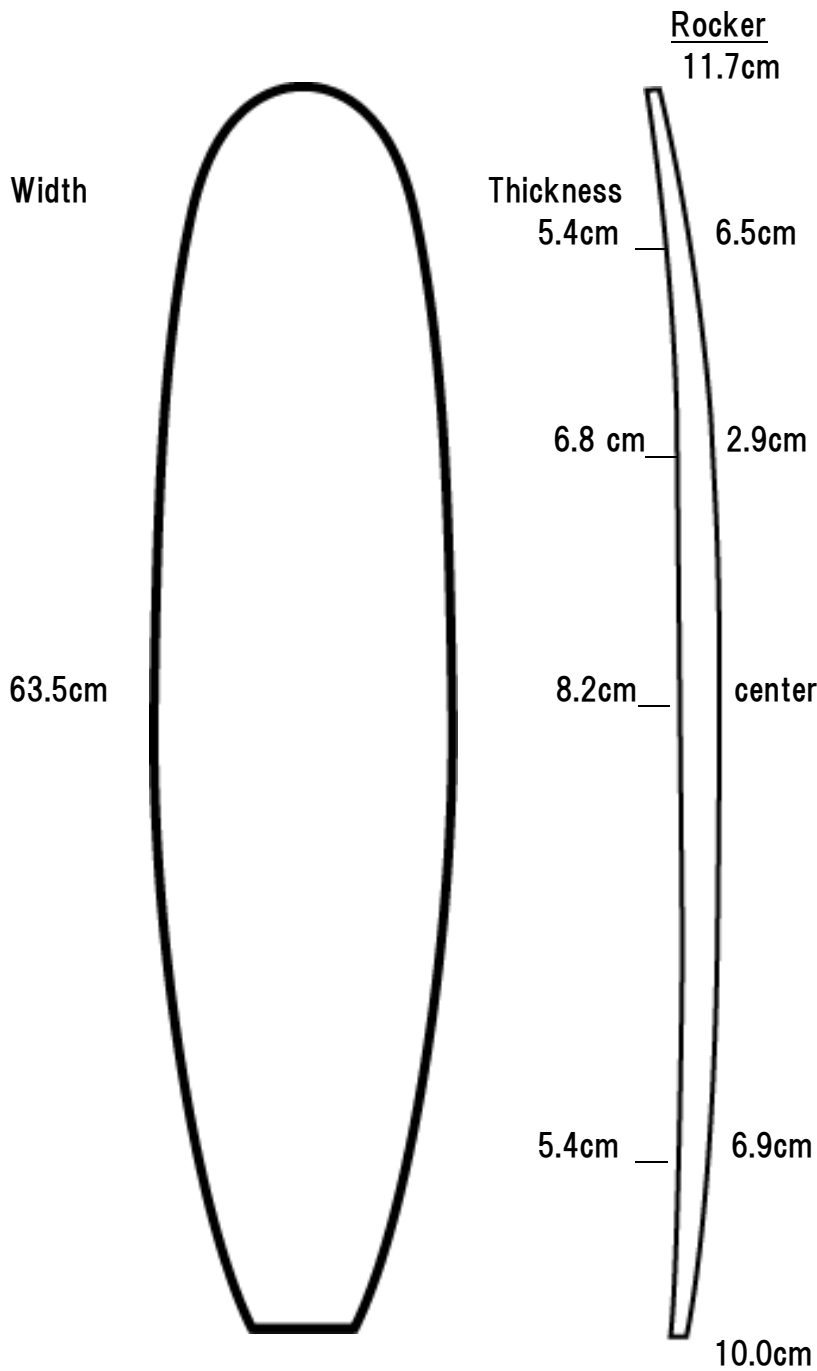

Actual Length	
Max. Width	
Max.Thickness	63.5cm
History	2011
Rocker	
Weights	x40
Stringer	1/4

データ数値 個体差あり