

ADVANCED TECHNOLOGY  
MADE IN AUSTRALIA

**BENNETT DION**

★ SURFBOARD  
FOAM SYSTEMS ★

# Shortboard Type

# Bennett-Dion AUST.

## Speed Shape Model

# 5'11"FRSS

Rocker 13.45cm

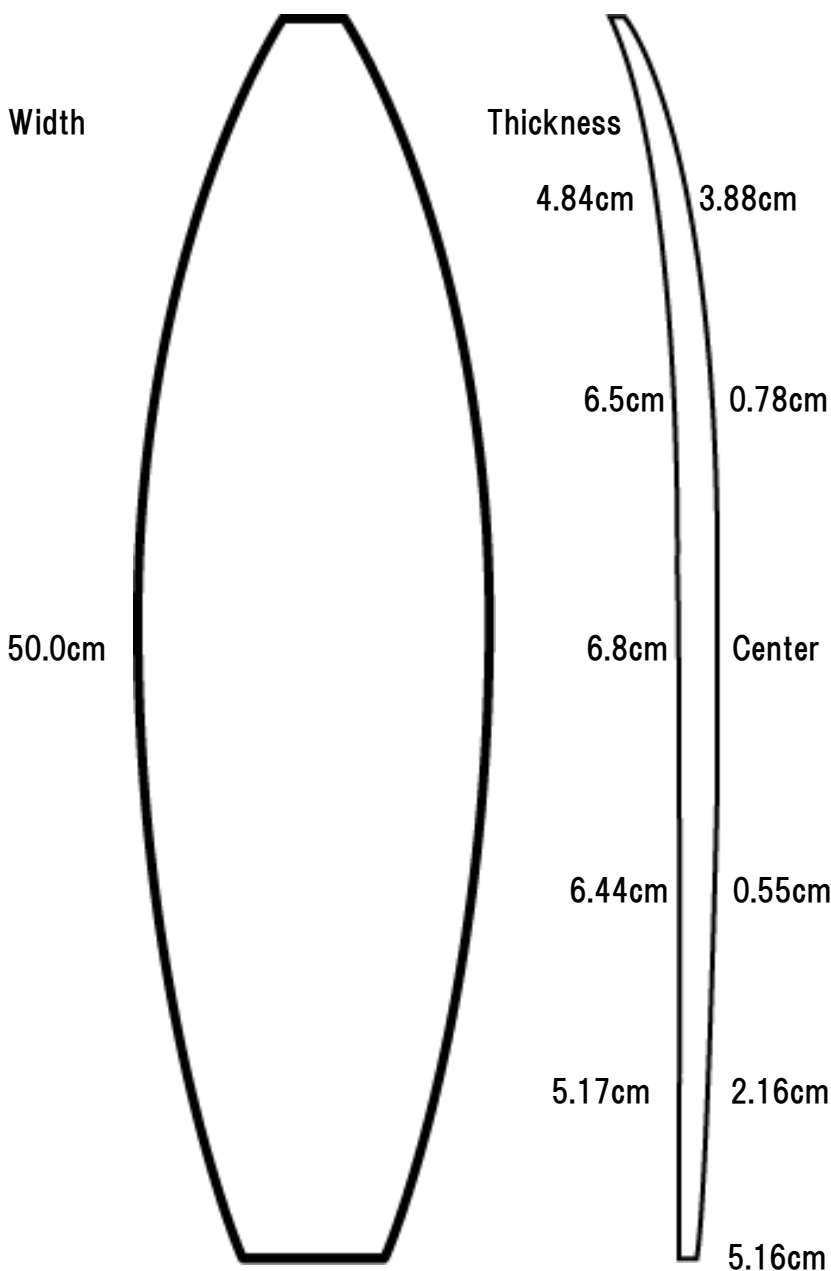

Deck Length	5'11
Max. Width	50cm
Max.Thickness	6.8 cm~
History	2016
Rocker	FR
Weights	UL
Stringer	1/8

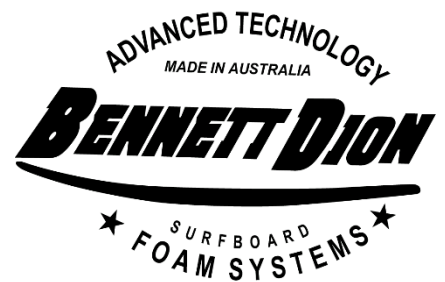

データ数値はあくまで参考値

\*アウトラインはカットされておりません (使用フォームによりアウトライン異なります)

Performance to all-rounder

# **Bennett-Dion AUST.**

## **Speed Shape Model**

# **6'2"FRSS**

Rocker 14.01cm

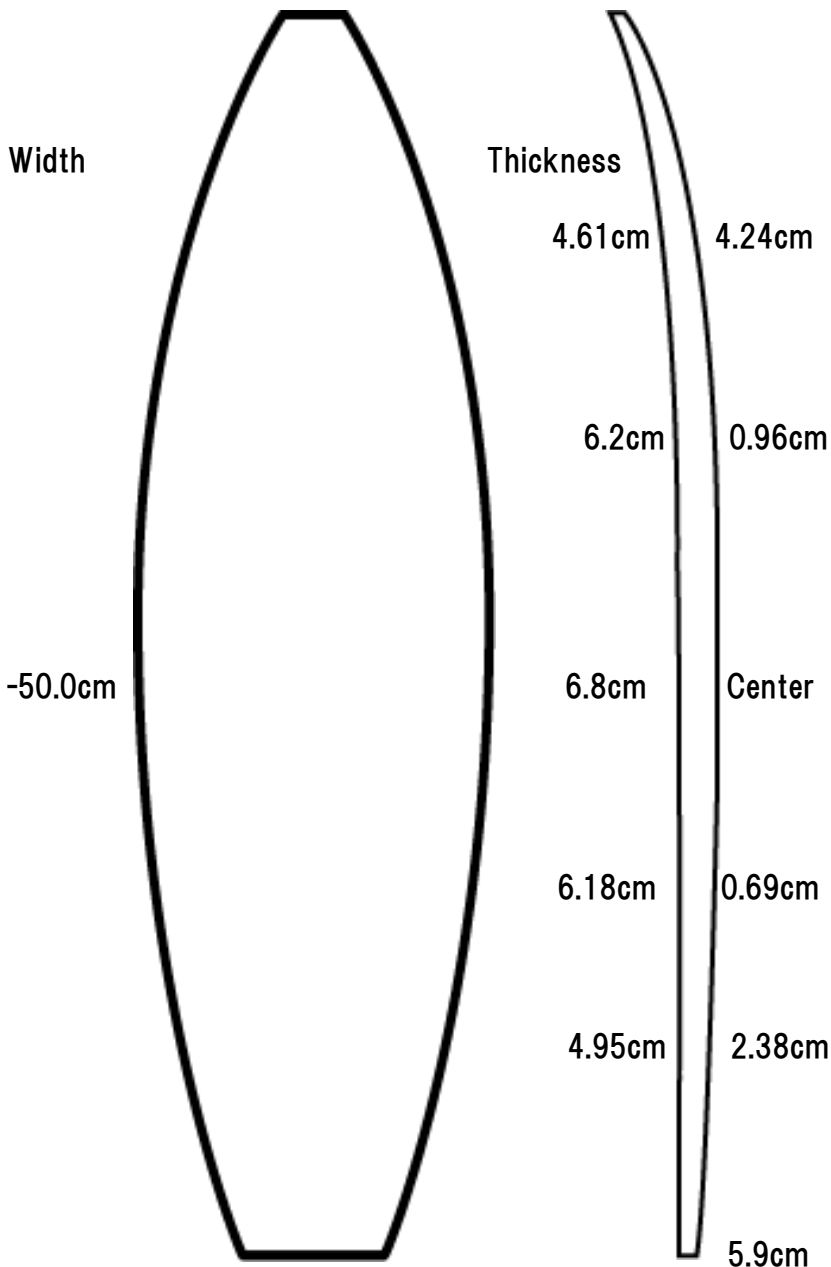

Deck Length	6'2
Max. Width	50cm
Max.Thickness	6.8 cm~
History	2016
Rocker	FR
Weights	UL
Stringer	1/8

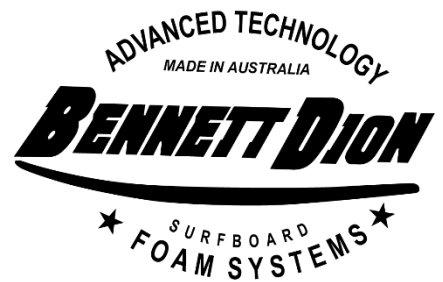

データ数値はあくまで参考値

\*アウトラインはカットされておりません (使用フォームによりアウトライン異なります)

*for performance or all-rounder*

 **Peak of Japan**

# Bennett-Dion AUST.

## 6'4"-D10

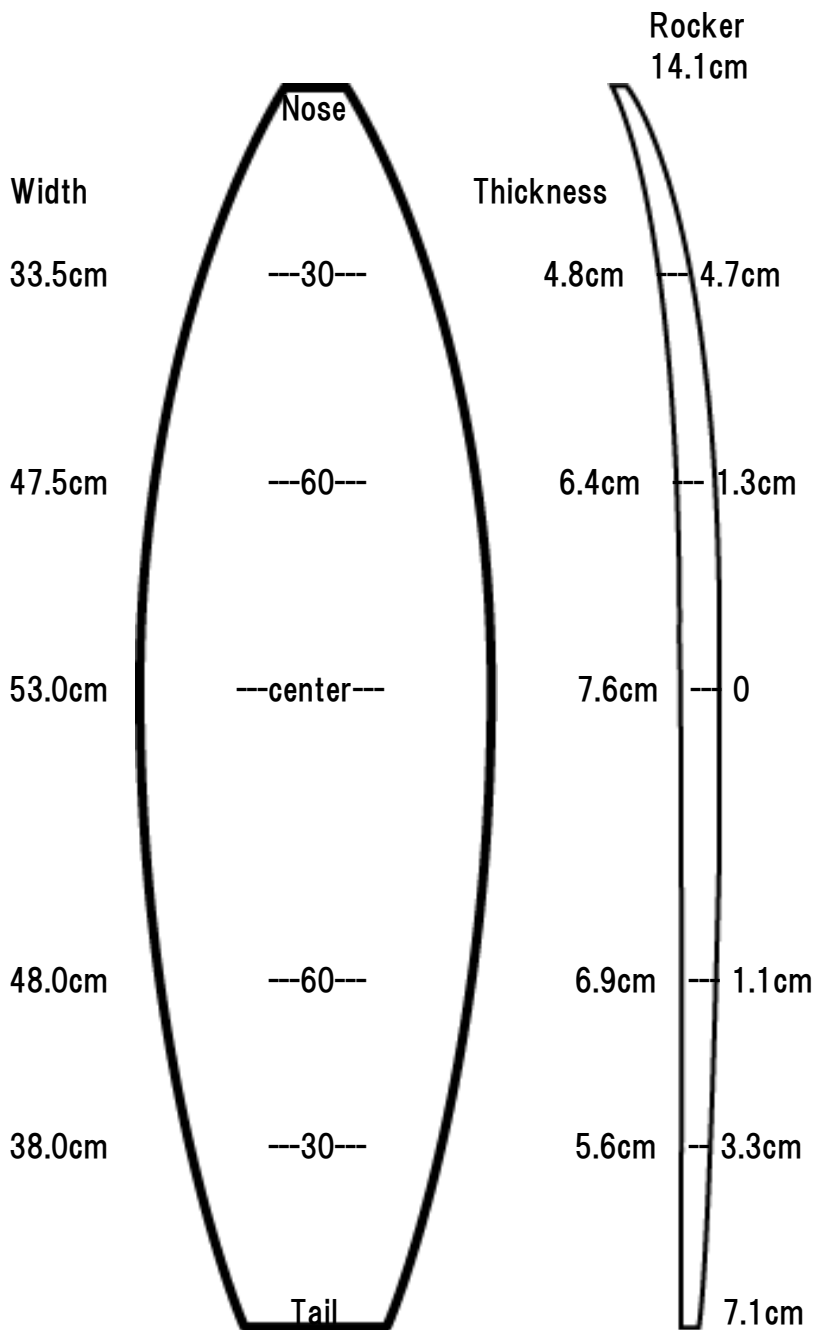

Bottom Length	198cm
Max. Width	53.0cm
Max.Thickness	7.6cm
History	2019
Rocker	D10
Weights	UL Team Pro
Stringer	1/8

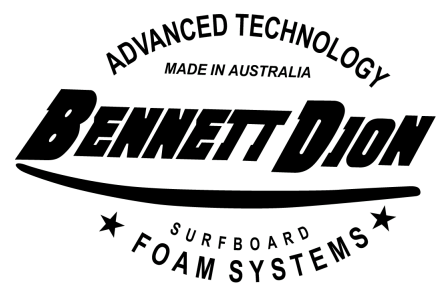

\*数値はあくまで目安の参考値

# Bennett-Dion AUST.

## 6'4-D19

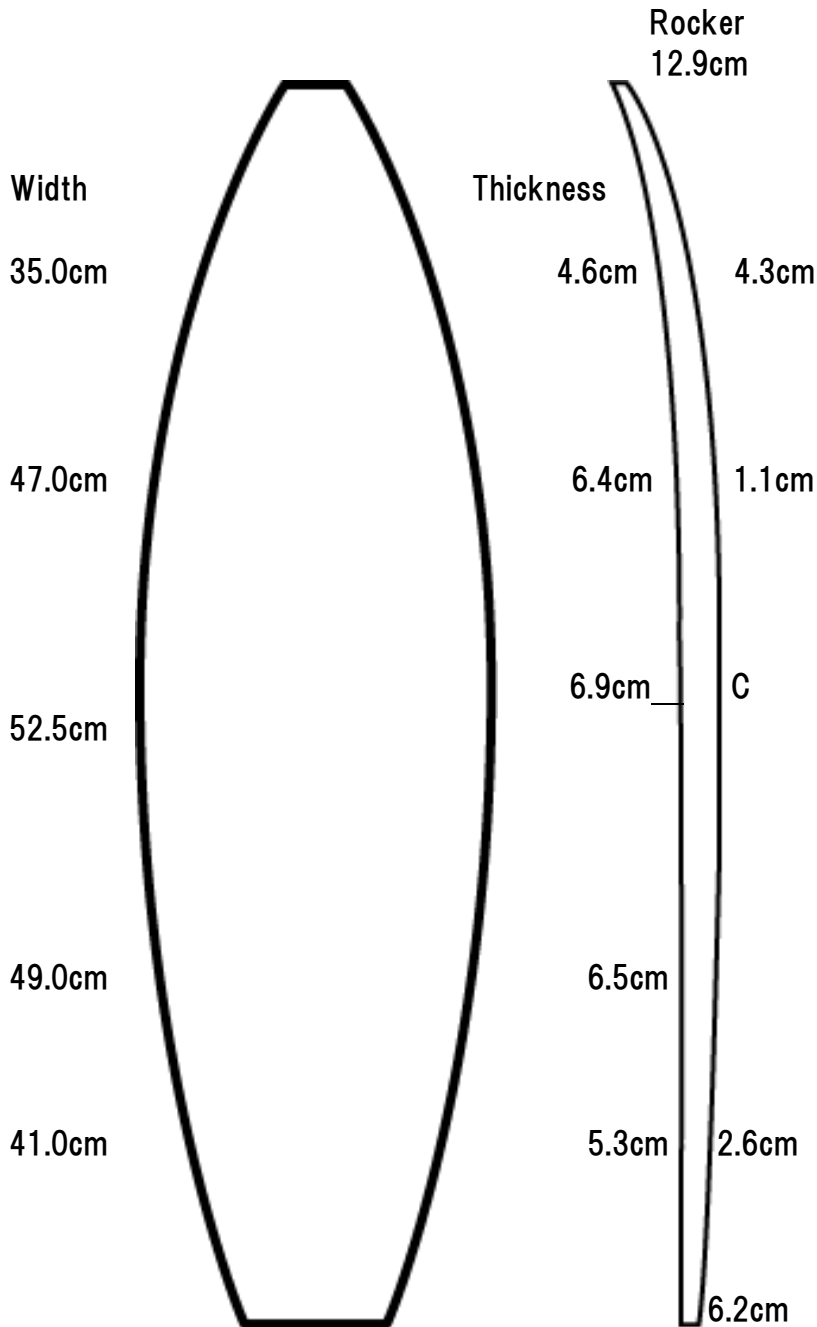

Bottom Length	195cm
Max. Width	52.5cm
Max.Thickness	6.9cm
History	2013
Rocker	671010
Weights	UL Team Pro
Stringer	1/8

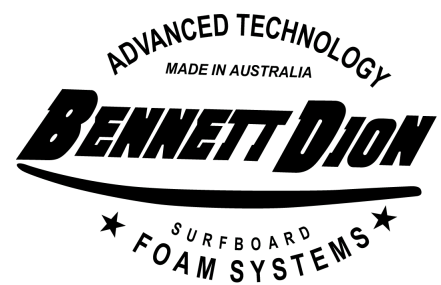

*for performance or all-rounder  
natural and versatile curve  
applied to 6'7 plug*

# Bennett-Dion AUST.

## 6'4-mor

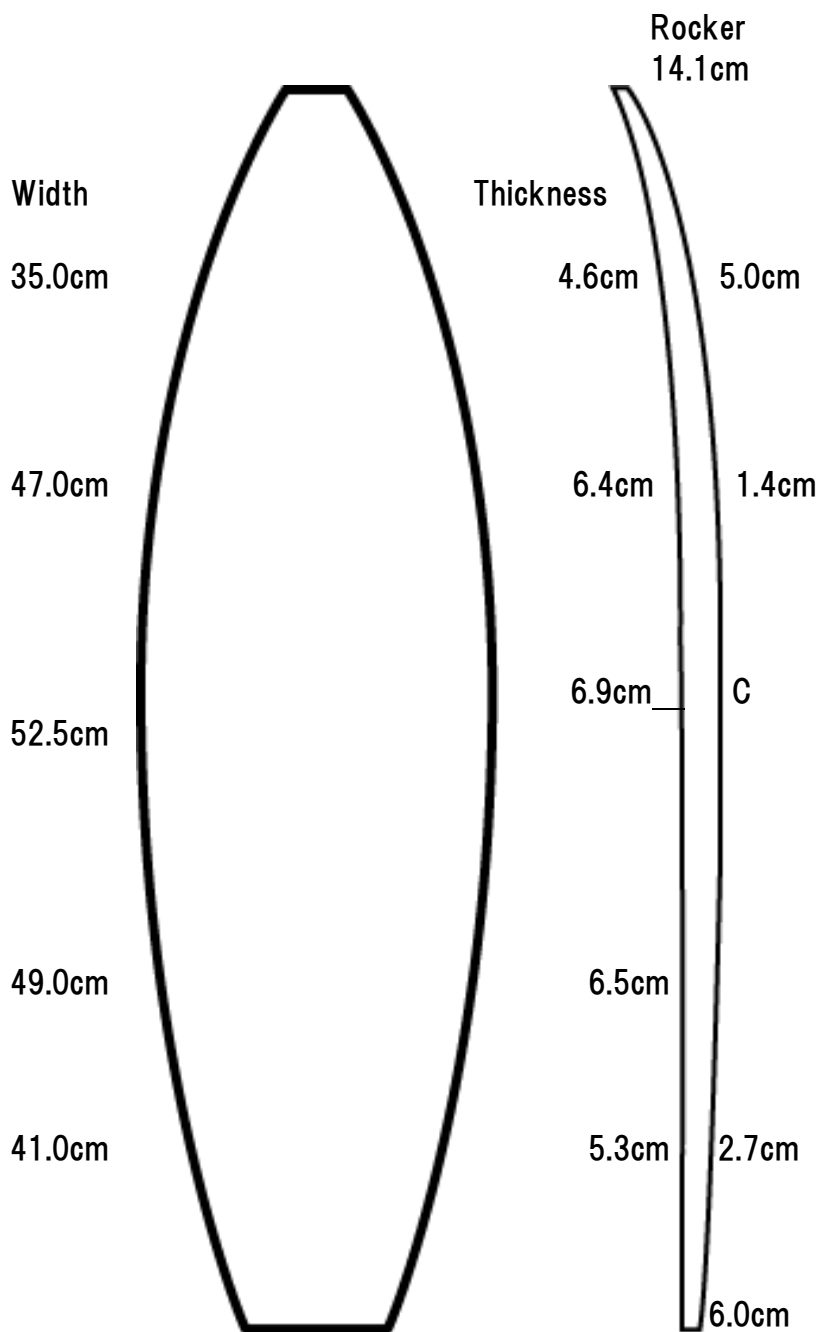

<b>Bottom Length</b>	195cm
<b>Max. Width</b>	52.5cm
<b>Max.Thickness</b>	6.9cm
<b>History</b>	2014
<b>Rocker</b>	67mor
<b>Weights</b>	UL Team Pro
<b>Stringer</b>	1/8

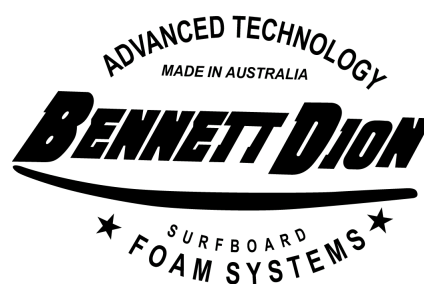

*Curvy rocker for performance or all-rounder  
Full model change from 6'4D3 model  
applied to 6'7 plug*

# Bennett-Dion AUST.

# 6'7" D47

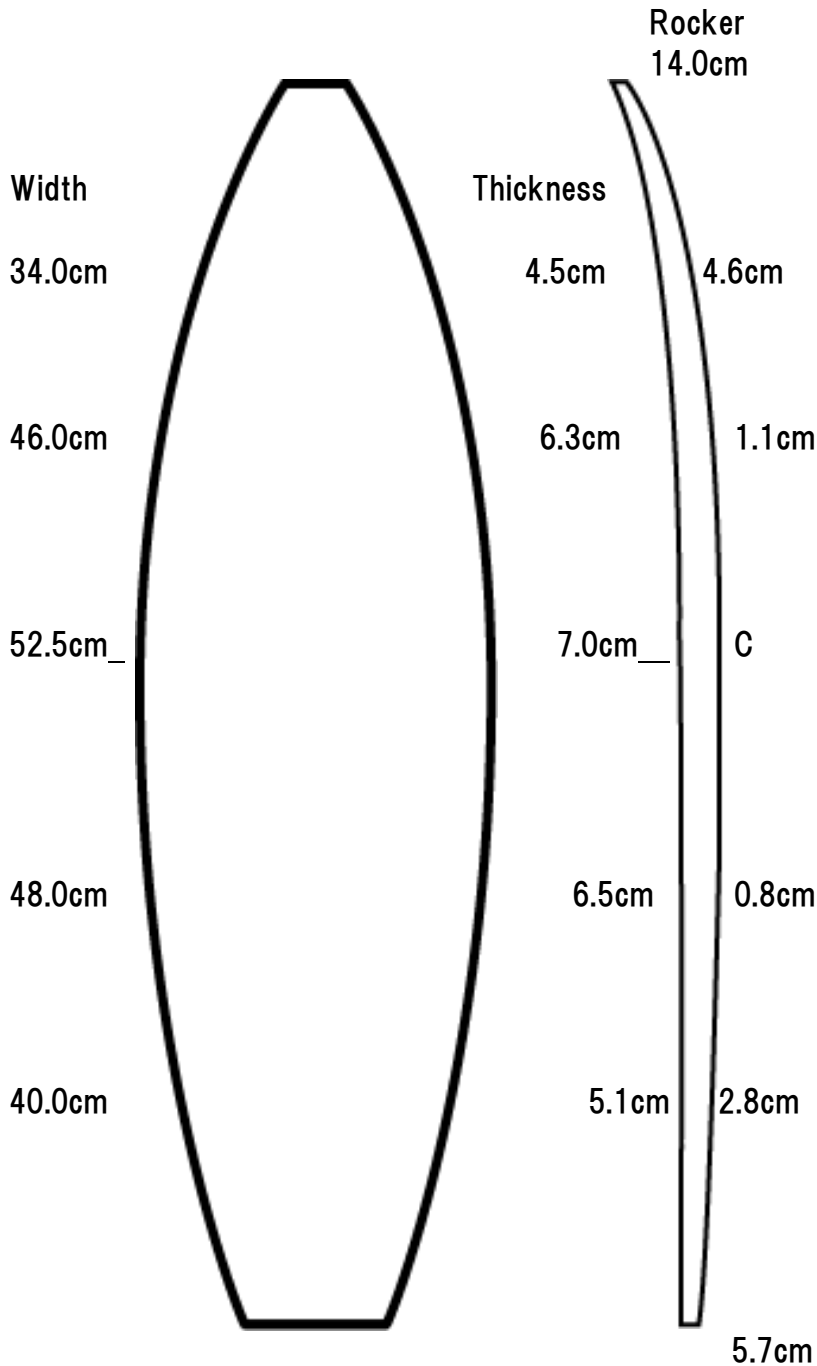

Actual Bottom Length	203.5cm
Max Width	52.5cm
Max Thickness	7.0cm
History	2013
Rocker	POJ4
Weights	UL
Stringer	1/8

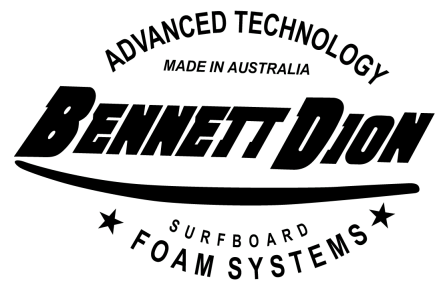

*for performance or all-rounder*

\*数値はあくまで目安参考値



# Bennett-Dion AUST.

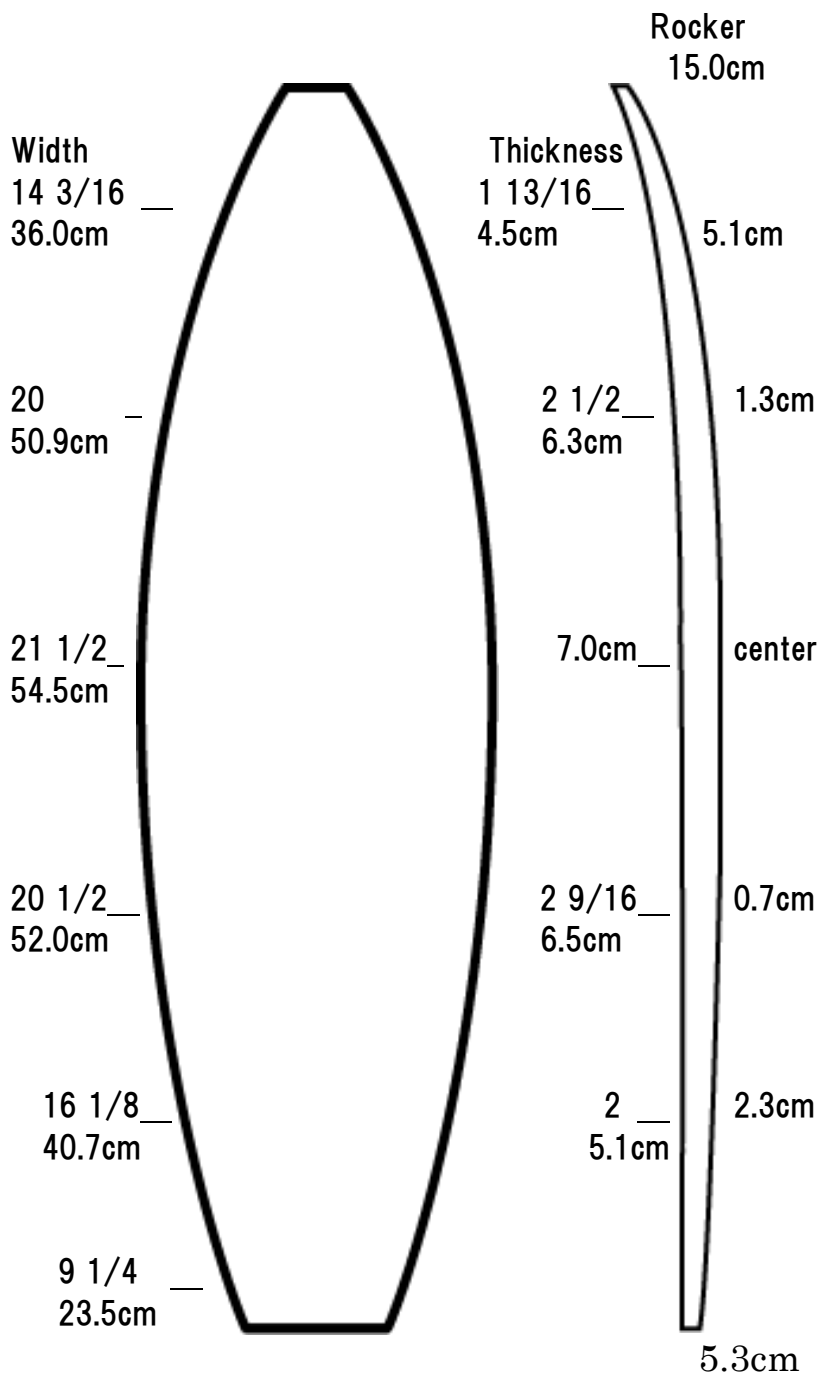

# 6'7"

## D69

Actual Length	6'07" 202.1cm
Maximum Width	21 1/2 54.5cm
Maximum Thickness	7.0cm
History	1997
Rocker	D69
Weights	UL Team Rider
Stringer	1/8

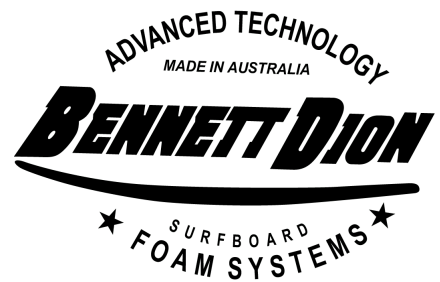

*originally designed for profile machine cut  
nose flip kind curve*

# Bennett-Dion AUST.

## 6'7 Thick SPR rocker

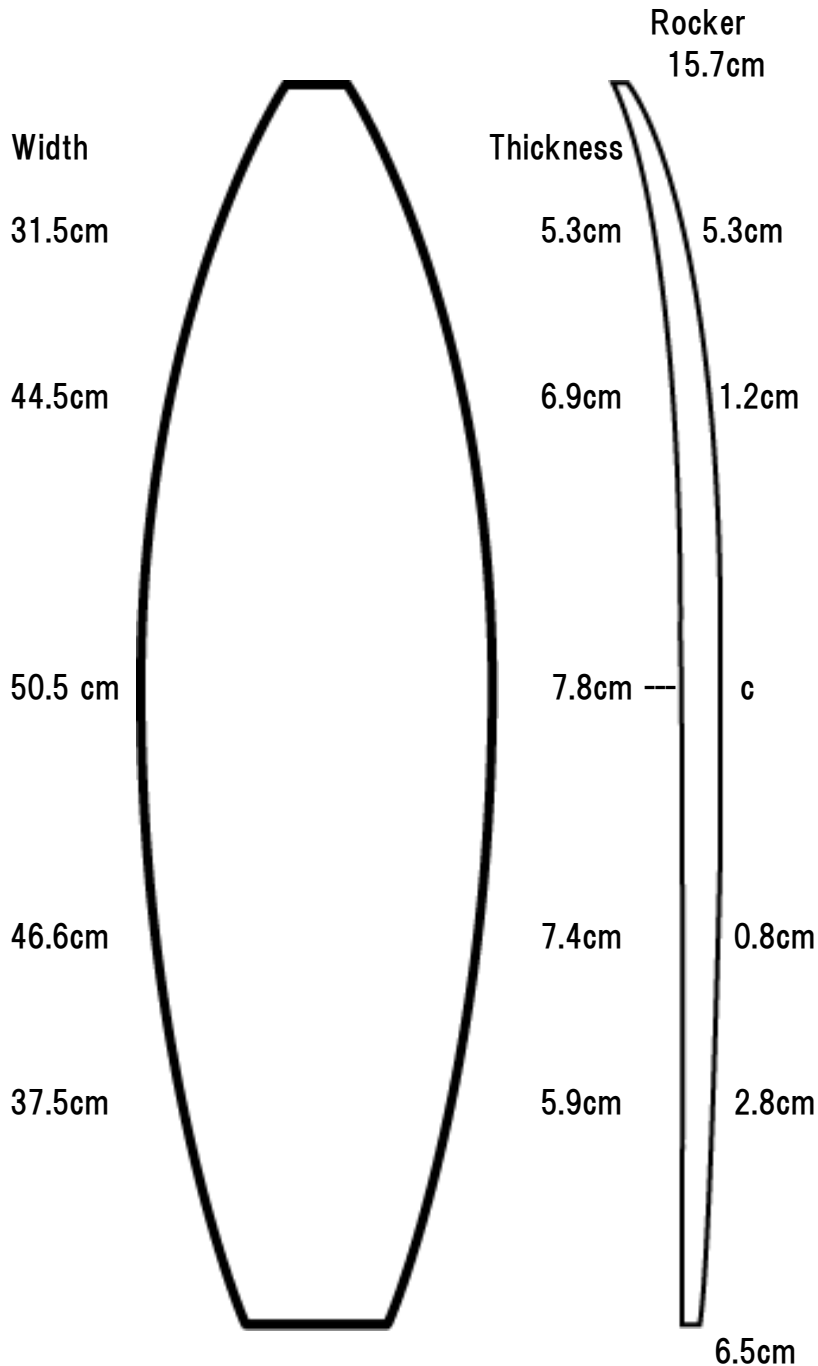

Actual Bottom Length	203cm
Max. Width	50.5cm
Max. Thickness	7.8cm
History	2014
Rocker	SPR
Weights	UL
Stringer	1/8

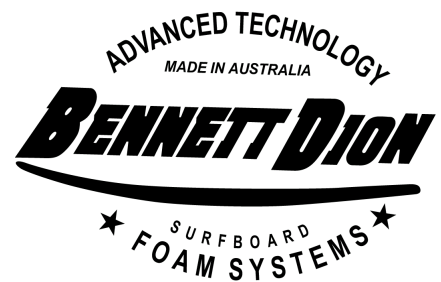

Thicker version of 6'7  
 Suitable for both hand shaping and profile machine cut  
 Tail kick version of 6'7-D69 model

# Bennett-Dion AUST.

## 6'7 Thick D69 rocker

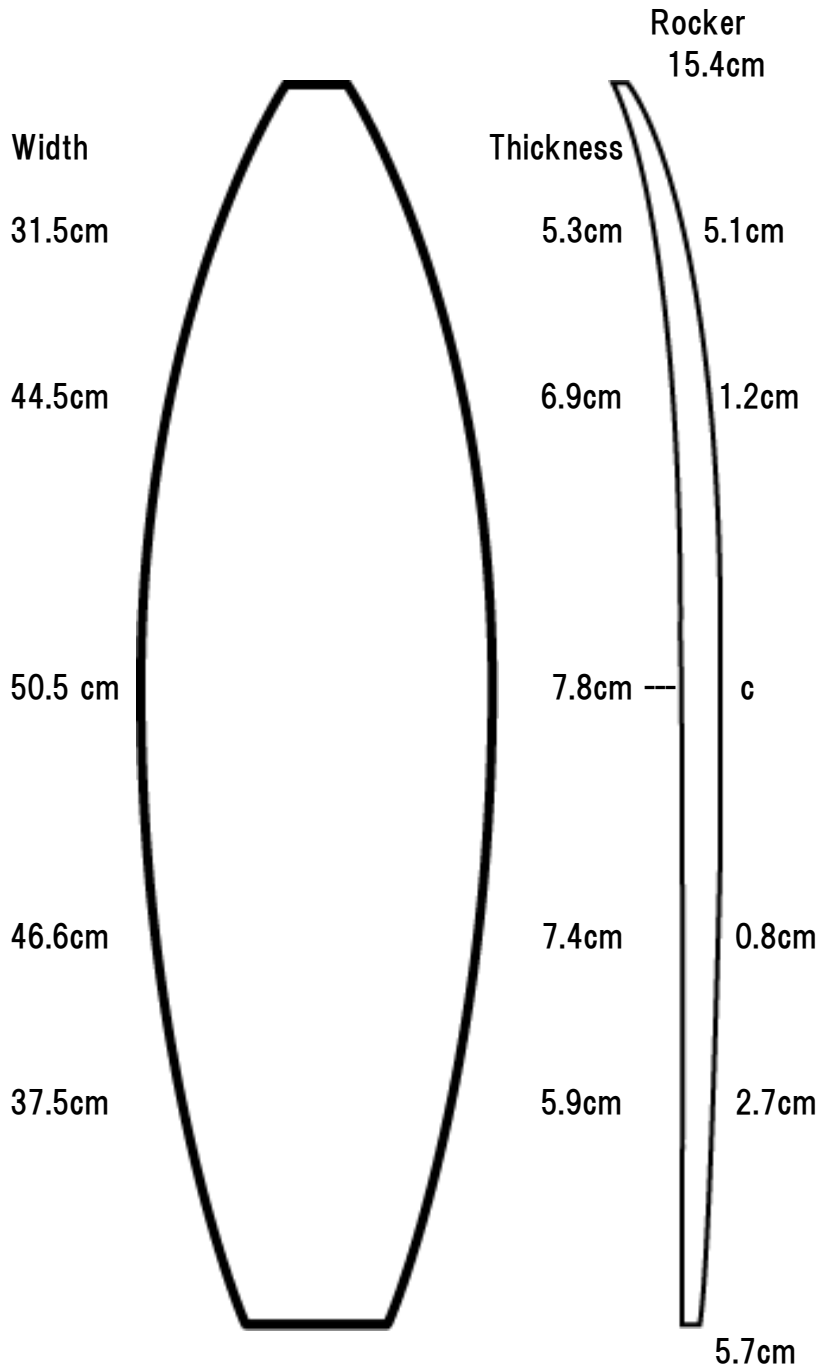

Actual Bottom Length	203cm
Max. Width	50.5cm
Max. Thickness	7.8cm
History	2014
Rocker	D69
Weights	UL
Stringer	1/8

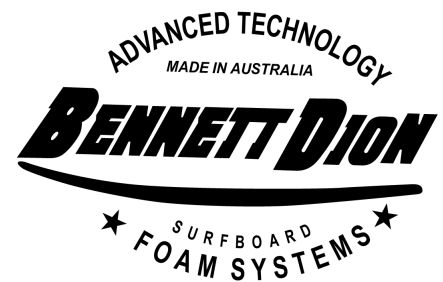

*Thicker version of 6'7  
Suitable for both hand shaping and profile machine cut*

# Bennett-Dion AUST.

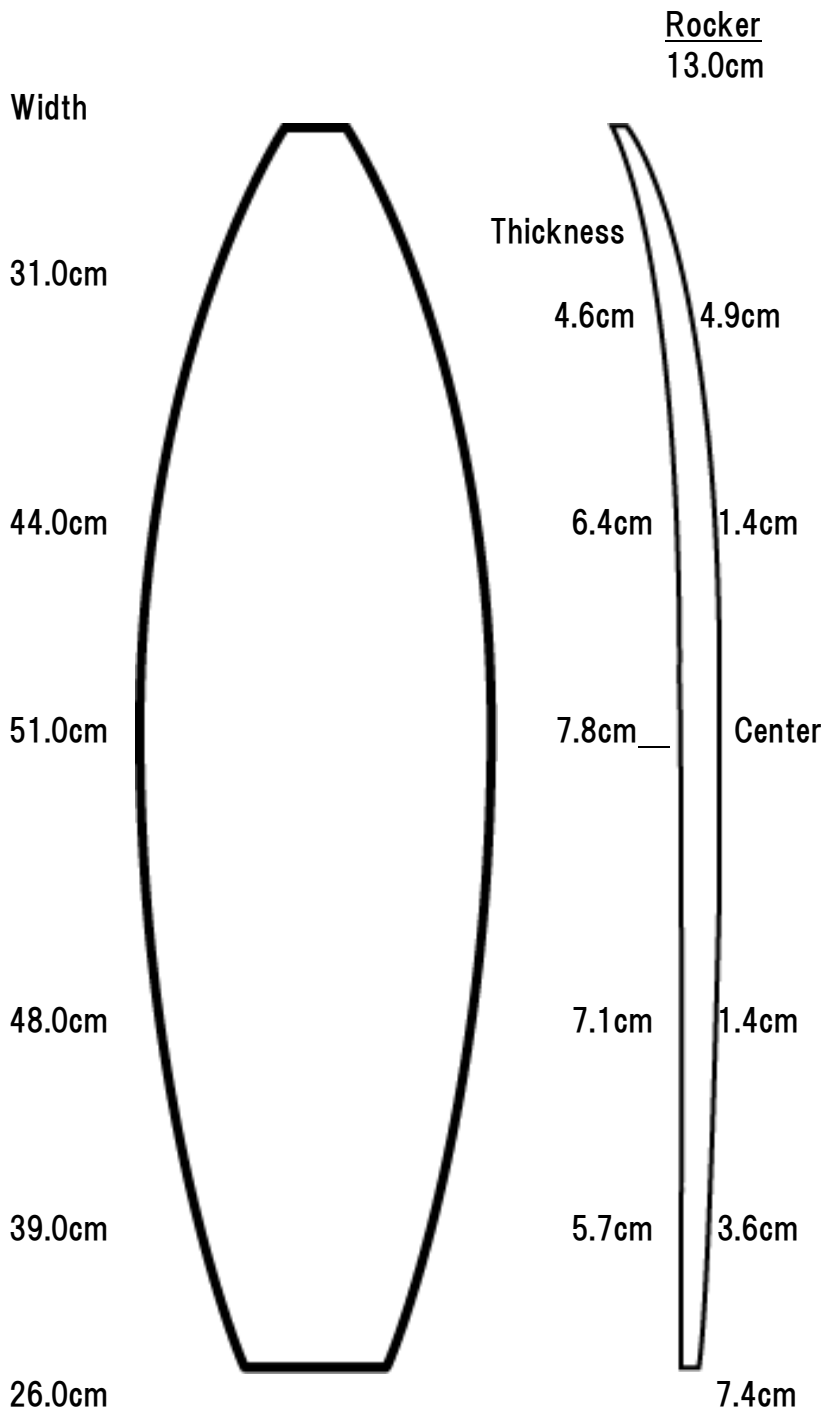

# 6'10"

Actual Bottom Length	212.0 cm
Max.Width	51.0cm
Max.Thickness	7.8cm
History	2014
Rocker	702-mor
Weights	SSL UL
Stringer	1/8 1/4 Redwood

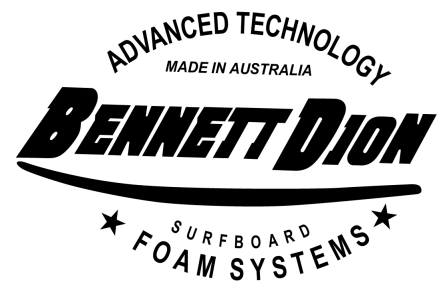

4inches chopped off tail from 7'2 plug  
for all-rounder  
adjustable to narrower mini-boards

# Bennett-Dion AUST.

## 6'10 Fat spr rocker

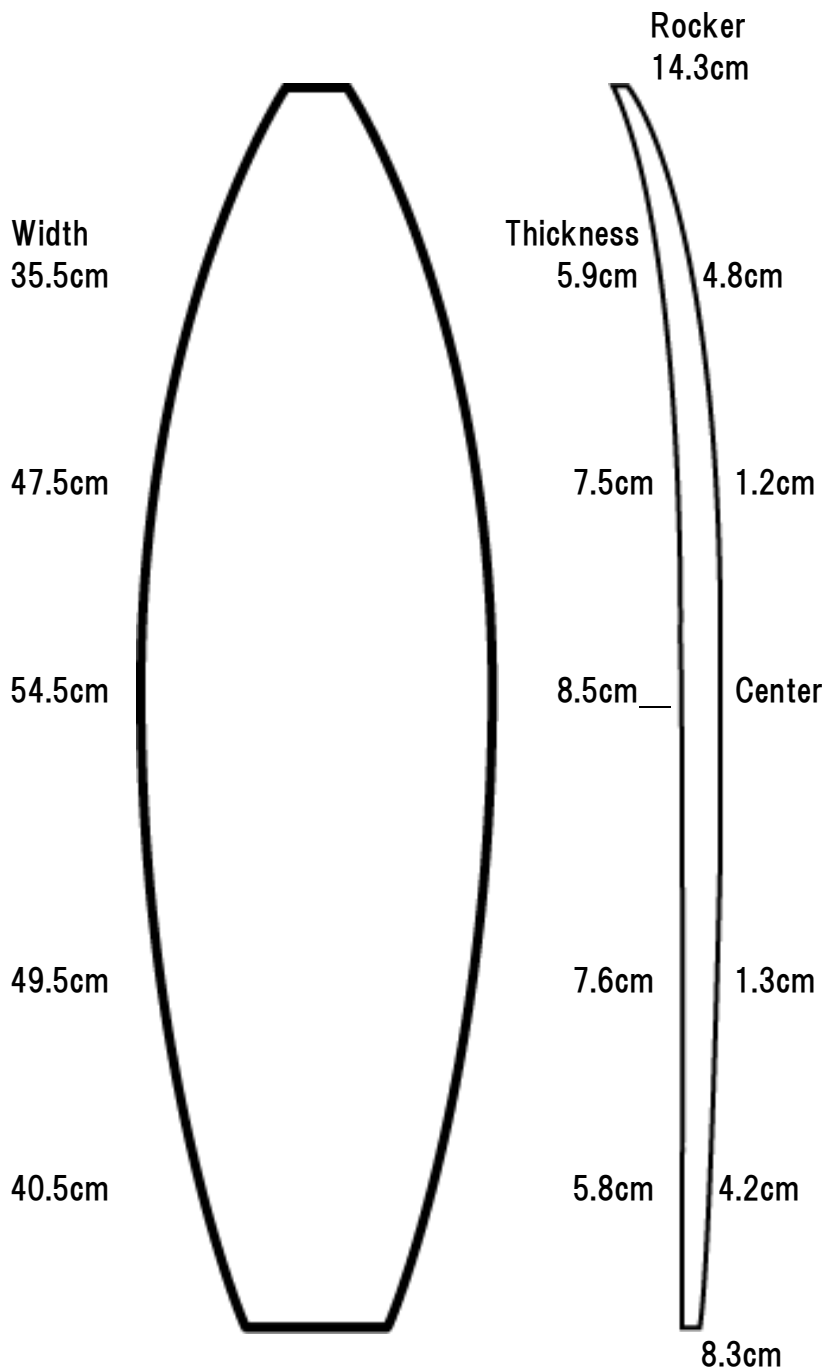

Actual Bottom Length	212.5 cm
Max.Width	54.5cm
Max.Thickness	8.5cm
History	2014
Rocker	SPR
Weights	UL
Stringer	1/8

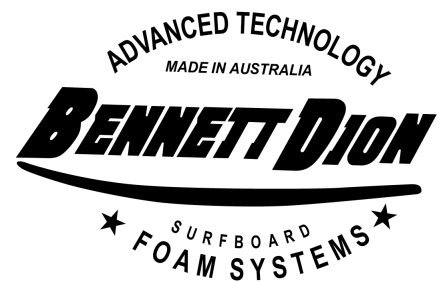

*Newly released plug in late 2014  
For all-round, mini, fish, retro, fatter models or whatever....  
Also machine profile cut friendly*

# Bennett-Dion AUST.

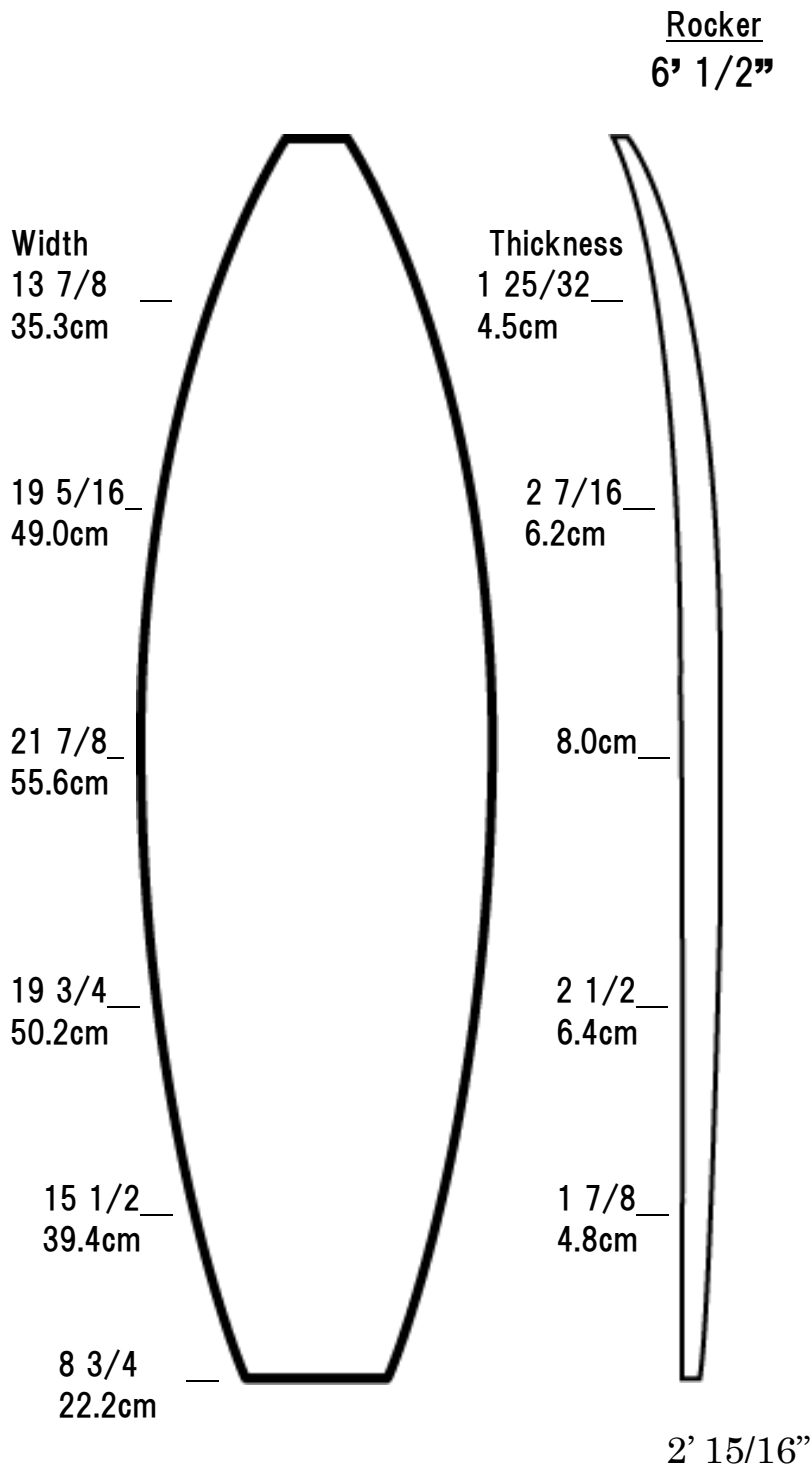

**7'2"**  
**D3**

Actual Length	7'02" 210.3cm
Maximum Width	21 7/8 55.6cm
Maximum Thickness	8.0cm
History	1998
Rocker	D3
Weights	SSL
Stringer	

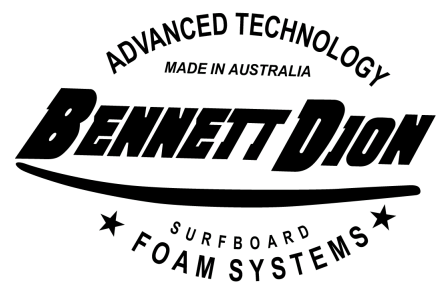

*gun boards for bigger waves*

# Bennett-Dion AUST.

Rocker  
6' 1/2"

# 7'7"

**D2**

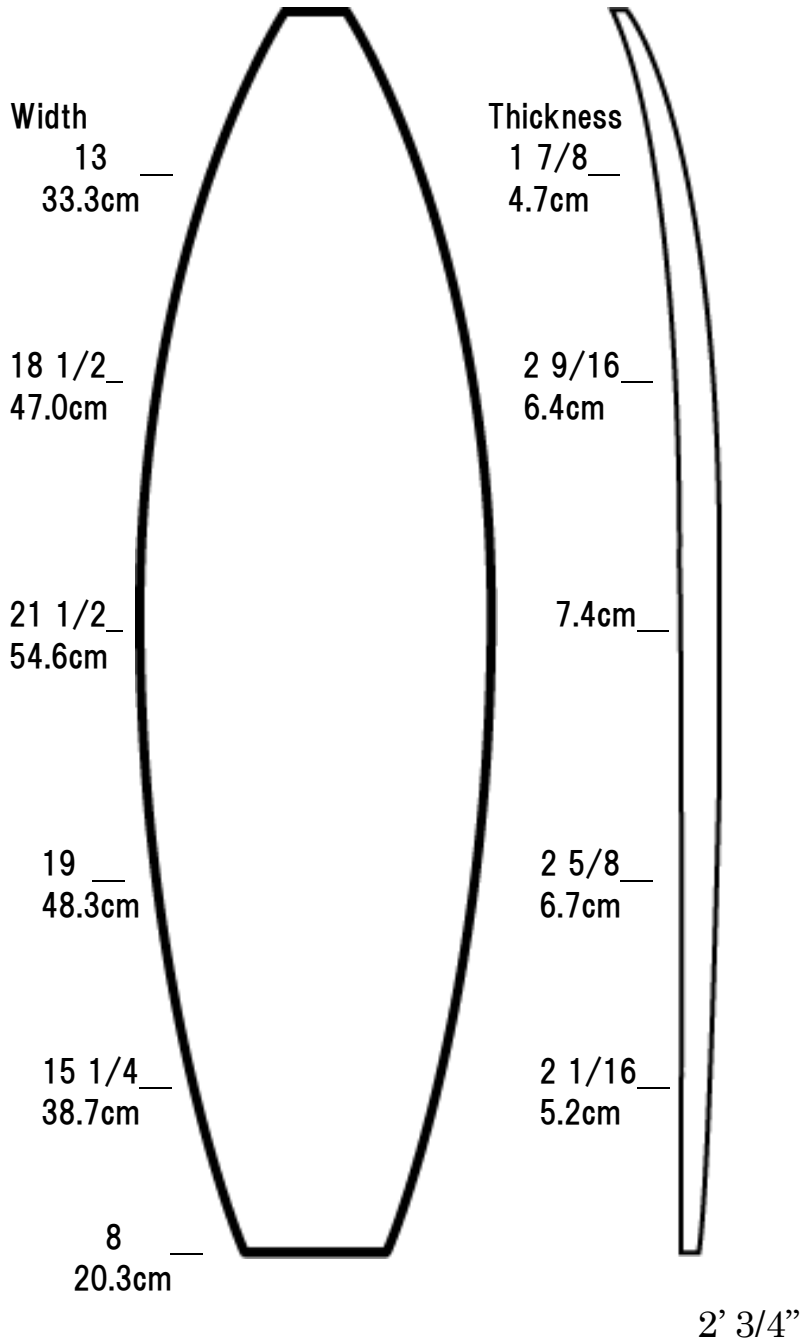

Actual Length	7'07" 231.4cm
Maximum Width	21 1/2 54.6cm
Maximum Thickness	7.4cm
History	1993
Rocker	D2
Weights	SSL
Stringer	

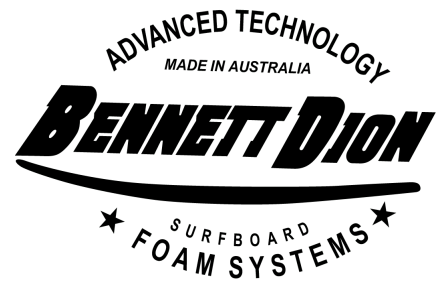

*gun boards for bigger waves*

Fish/Retro  
Type



# Bennett-Dion AUST.

## Speed Shape Model

### 5'10"NBSS

Rocker 10.76cm

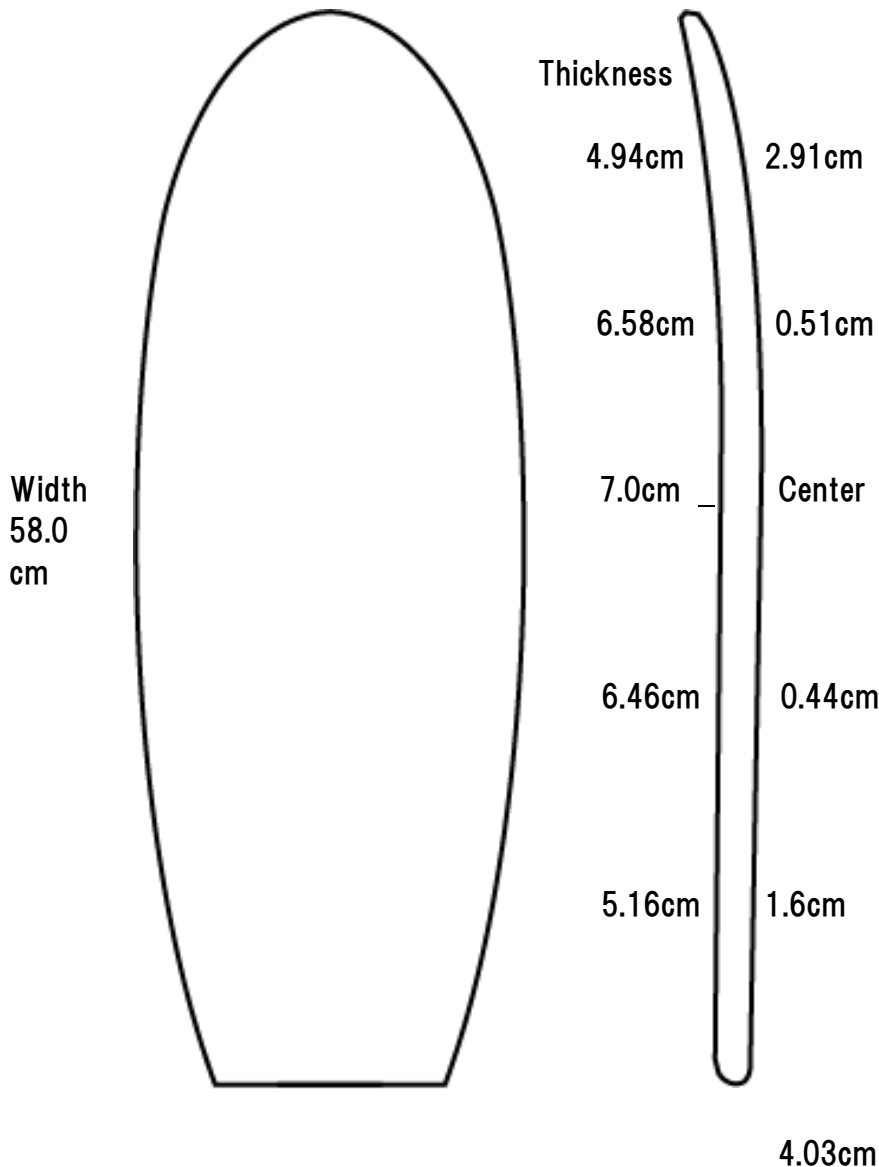

Deck Length	5'10"
Max. Width	-58.0cm
Max.Thickness	6.8 to 7.2cm
History	2016
Rocker	NB
Weights	UL
Stringer	1/8

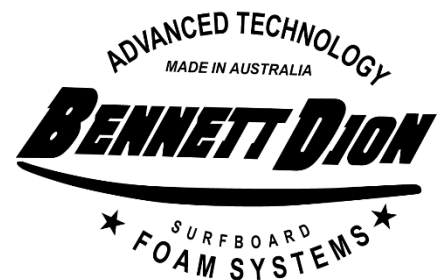

\*データ数値はあくまで参考値

\*アウトラインはカットされておりません (使用フォームによりアウトライン異なります)

*for retro or fish boards  
small miniboards also suited*

# **Bennett-Dion AUST.**

## **Speed Shape Model**

Rocker 11.37cm

# 6'2"NBSS

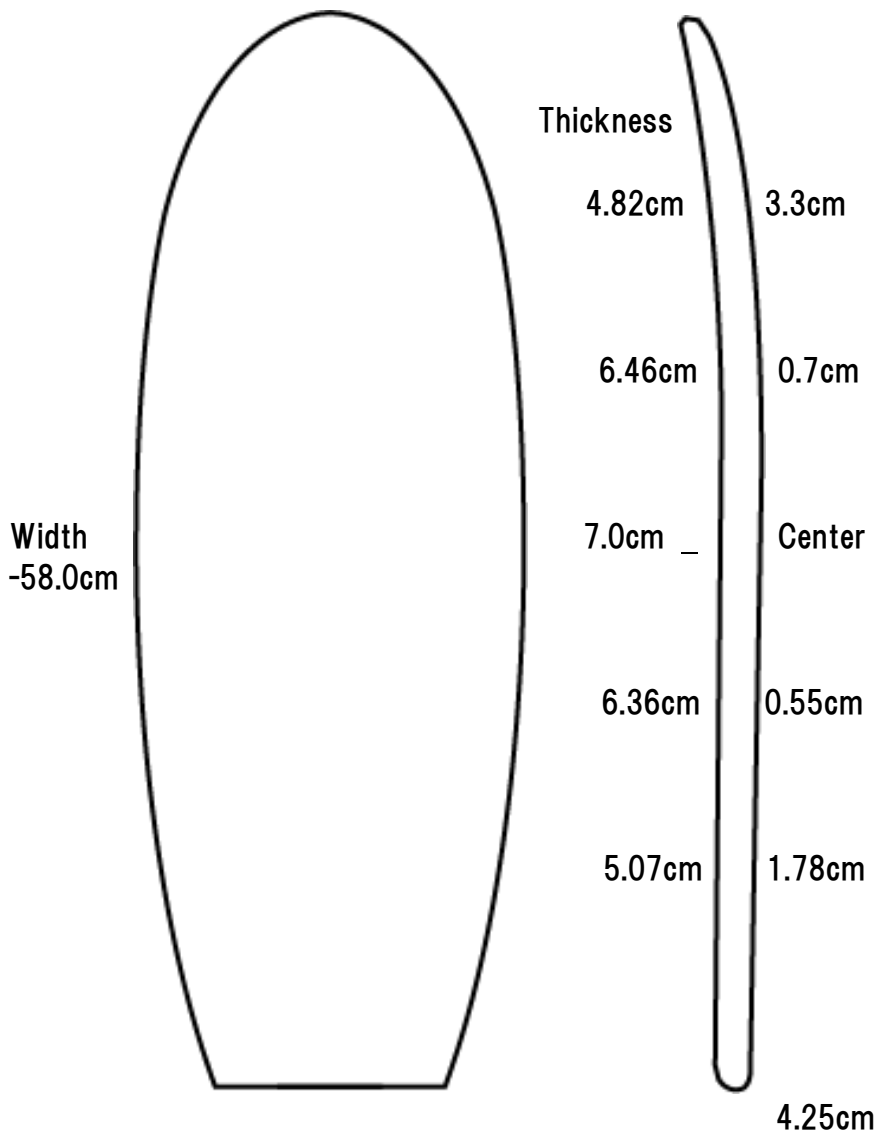

Deck Length	6'2"
Max. Width	58.0cm
Max.Thickness	6.8 to 7.2 cm
History	2016
Rocker	NB
Weights	UL
Stringer	1/8

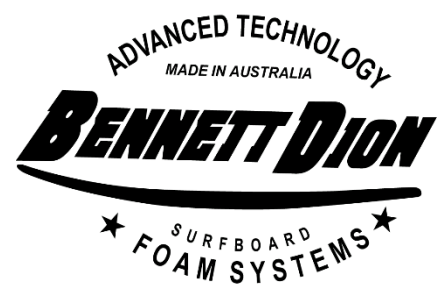

データ数値はあくまで参考値

\*アウトラインはカットされておりません (使用フォームによりアウトライン異なります)

*for retro or fish boards  
small minibboards also good*

# Bennett-Dion AUST.

Rocker 10.5cm

# 6'2''F

*DDR rocker*

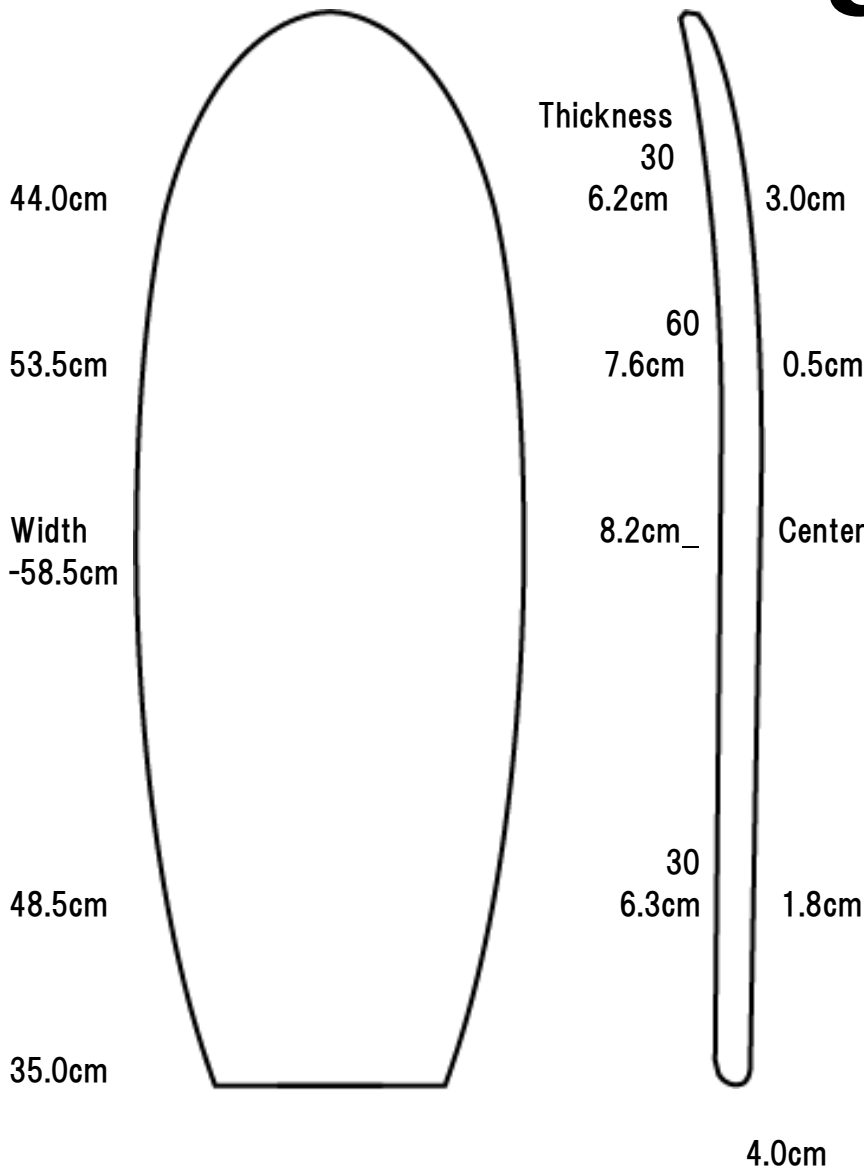

Actual Length	6'2''
Max. Width	Under 58.5cm
Max.Thickness	8.2cm
History	2011
Rocker	DDR
Weights	SSL UL
Stringer	1/8

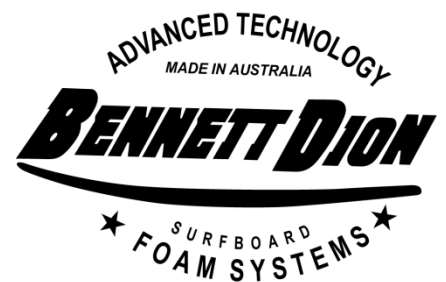

*for retro or fish boards*

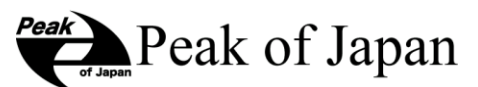

# Bennett-Dion AUST.

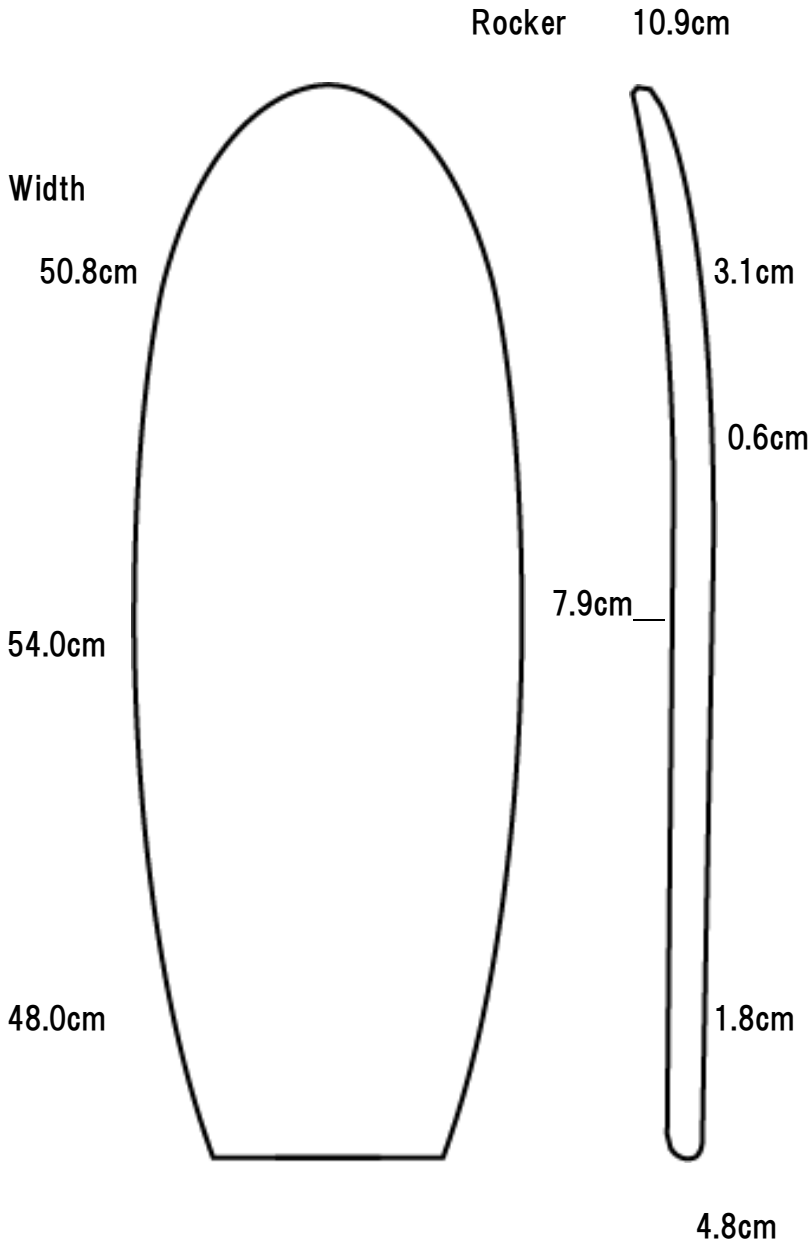

# 6'5"

## KB5

Actual Length	6'05" 197cm
Maximum Width	60.3cm
Maximum Thickness	7.9cm
History	
Rocker	KB5
Weights	SSL
Stringer	1/8

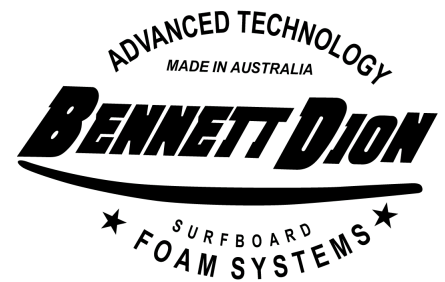

*originally designed for knee boards  
versatile for fish/retro boards*

# Bennett-Dion AUST.

# 6'9"

## F5

Width  
7 7/8 20.0cm

Rocker  
11.4cm

18 13/16  
47.8cm

Thickness  
2 1/8  
5.4cm

23 5/8  
60.0cm

3 1/16  
7.8cm

24 1/8  
61.3cm

8.4cm

18 7/8  
48.0cm

2 15/16  
7.5cm

18 3/8  
46.7cm

2 3/16  
5.6cm

12 15/16 22.7cm

3.8cm

Actual Length	6'09" 207.5cm
Maximum Width	24 1/8 61.3cm
Maximum Thickness	8.4cm
History	Terry Martin & Hobie 2007
Rocker	F5
Weights	SSL
Stringer	

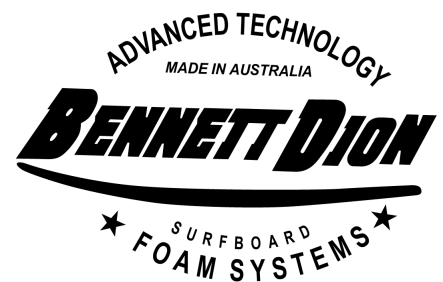

*for retro or fish boards  
low, natural curve*

# Bennett-Dion AUST.

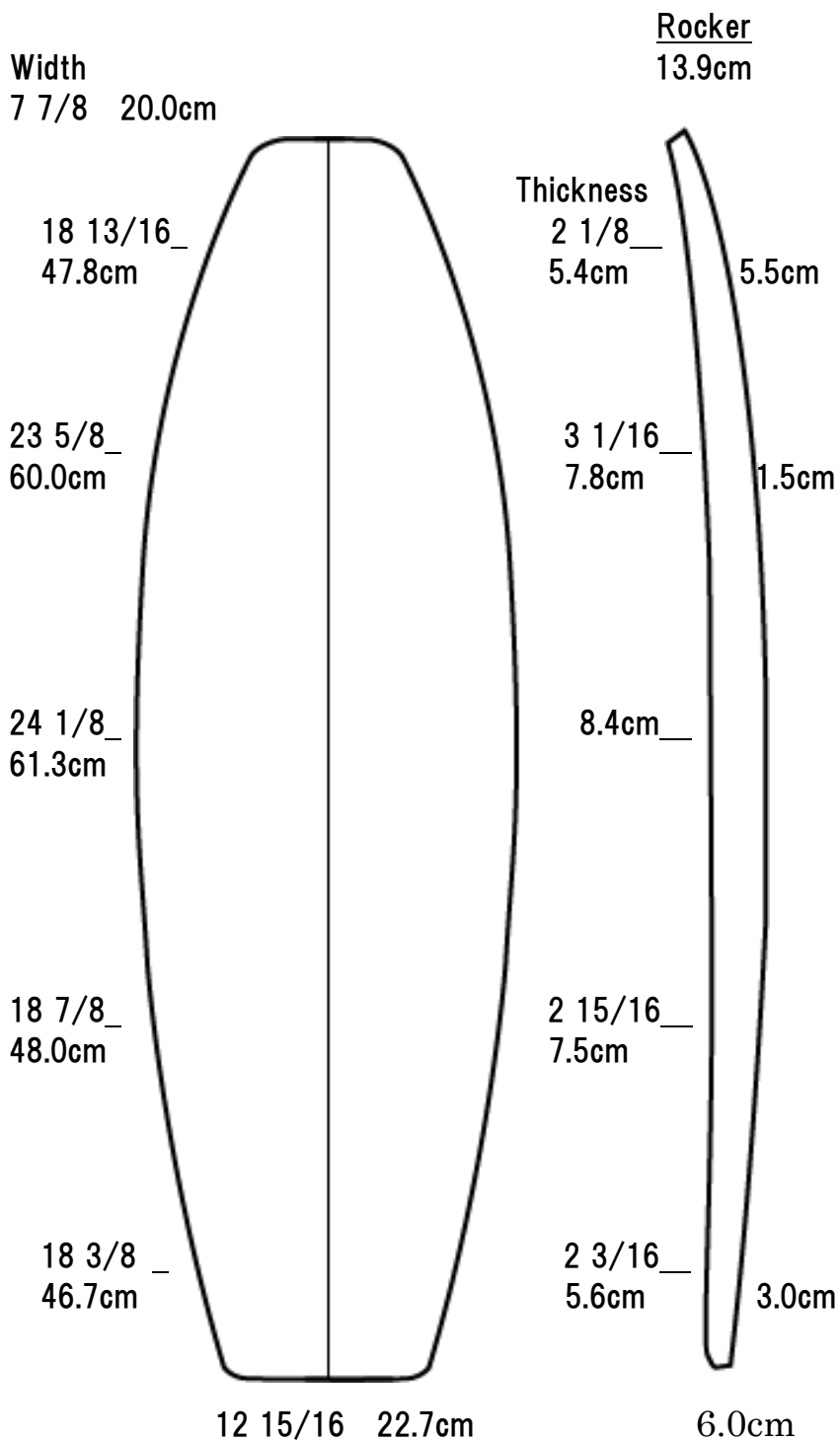

# 6'9"

## F2 Rocker

Actual Length	6'09" 207.5cm
Maximum Width	24 1/8 61.3cm
Maximum Thickness	8.4cm
History	Terry Martin & Hobie 2007
Rocker	F2
Weights	
Stringer	

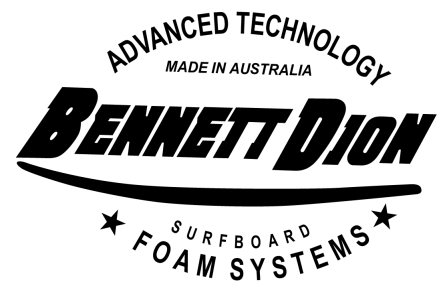

*for retro or fish boards  
curvy rocker*

Funboard Type

# **Bennett-Dion AUST.**

## **Speed Shape Model**

Rocker  
10.6cm

# **7'3MMss**

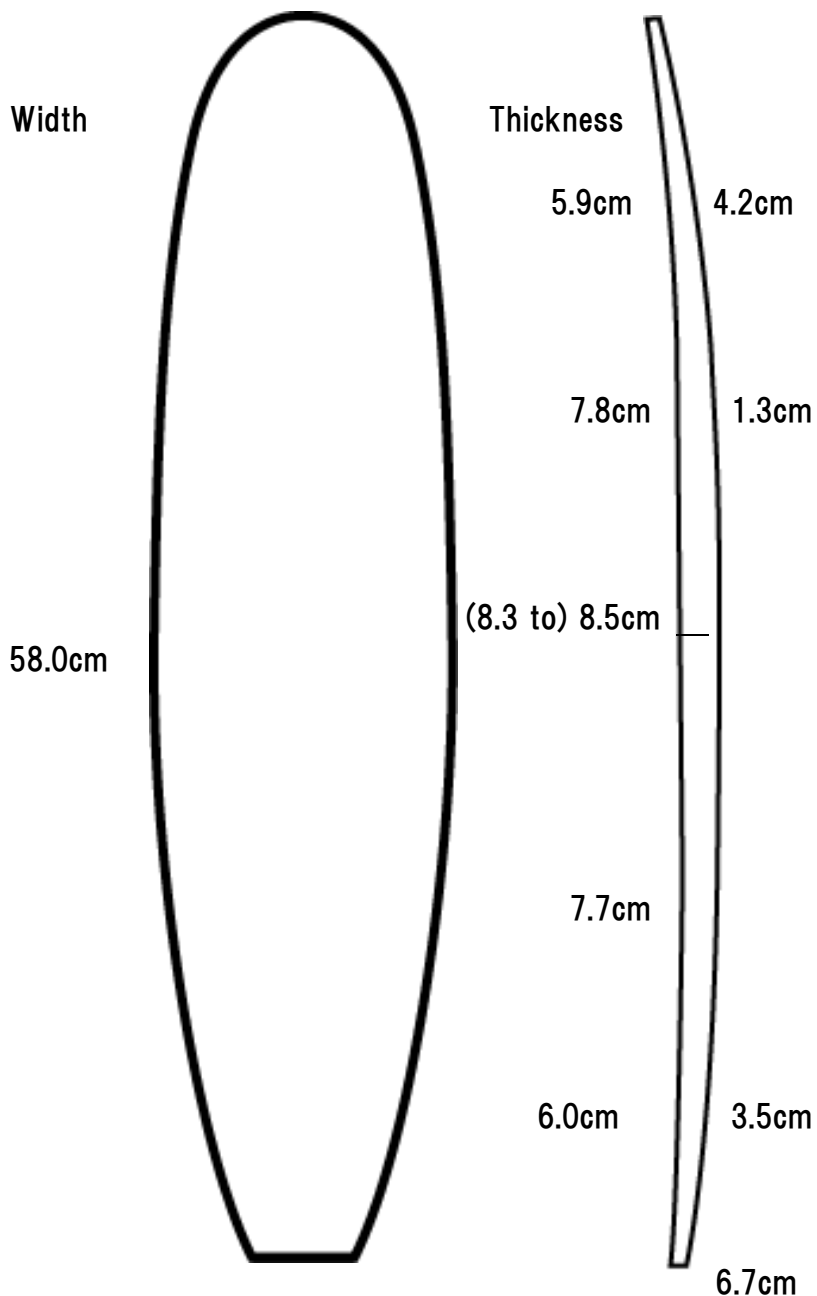

<b>Actual Length</b>	<b>223.0cm</b>
<b>Max.Width</b>	<b>58.00cm</b>
<b>Max.Thickness</b>	<b>8.3 to 8.5cm</b>
<b>History</b>	<b>2013</b>
<b>Rocker</b>	
<b>Weights</b>	<b>SSL</b>
<b>Stringer</b>	<b>1/4</b>

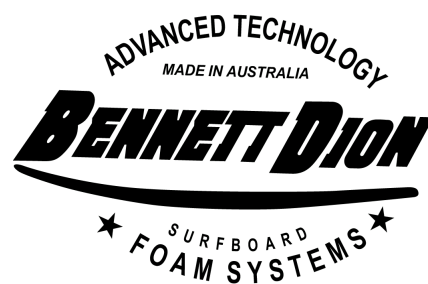



# **Bennett-Dion AUST.**

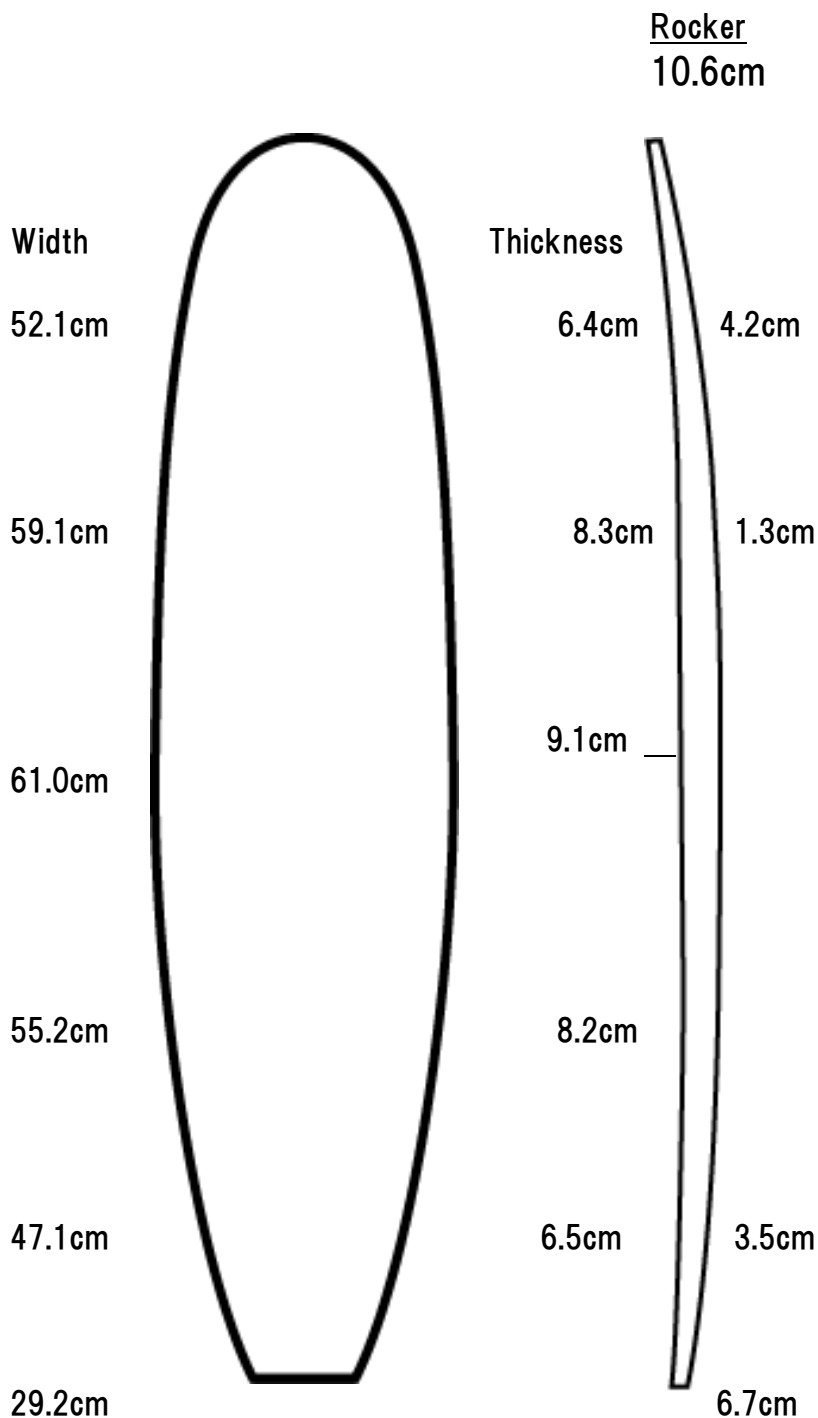

## **7'3mm** **MM21 Rocker**

<b>Actual Length</b>	<b>7'03"</b> <b>222.0cm</b>
<b>Max.Width</b>	<b>61.00cm</b>
<b>Max.Thickness</b>	<b>9.1cm</b>
<b>History</b>	<b>2011 NEW</b>
<b>Rocker</b>	<b>MM21</b>
<b>Weights</b>	<b>SSL</b>
<b>Stringer</b>	<b>1/4</b>

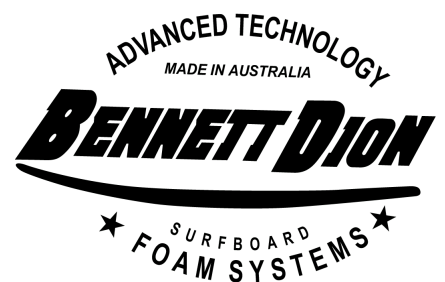

This newly made 7'3 is thicker and wider all over than the original, ideal for small mini mals, retro fun shapes, big guy fishes or single fins and mini-longs. Will suit a wide range of rockers and be easy to machine and hand shape.

# Bennett-Dion AUST.

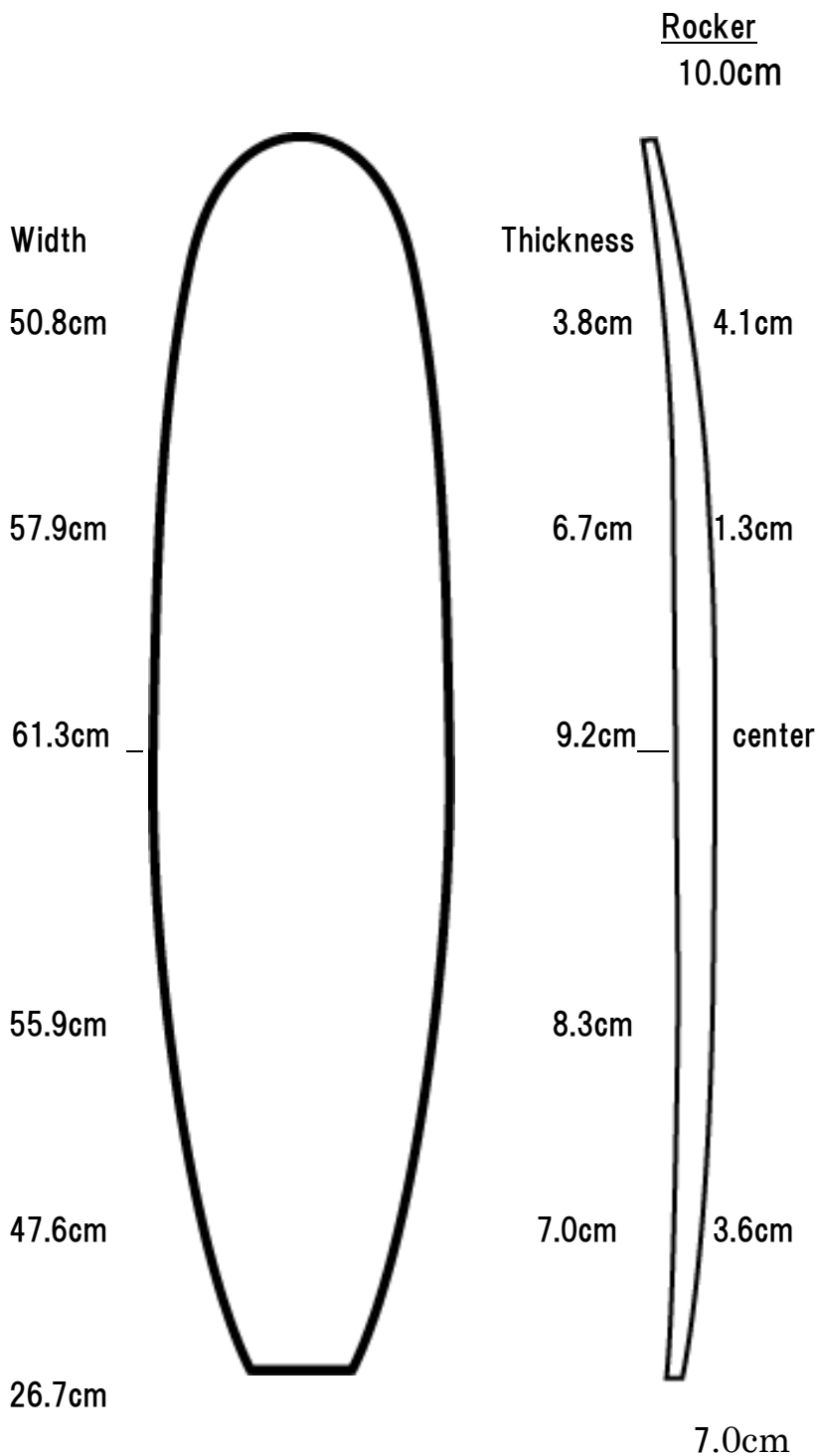

**7'7mm**  
**MM21 Rocker**

Actual Length	7'07" 1/4 234.69cm
Max.Width	61.60cm
Max.Thickness	9.2cm
History	2011 NEW
Rocker	MM21
Weights	SSL
Stringer	1/4

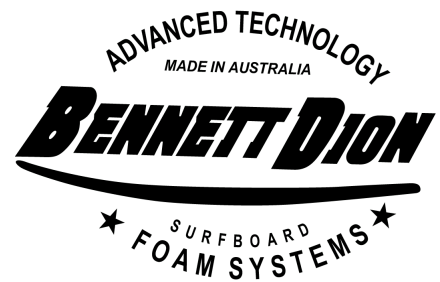

Based on the original 7'7 Mini Mal with added width and thickness throughout. Will suit a wider range of plan shapes and rocker templates for mini mals, big guy fun shapes, large fish, retro shapes and mini longs. Ideal to either machine or hand shape.

# Bennett-Dion AUST.

# 8'4"

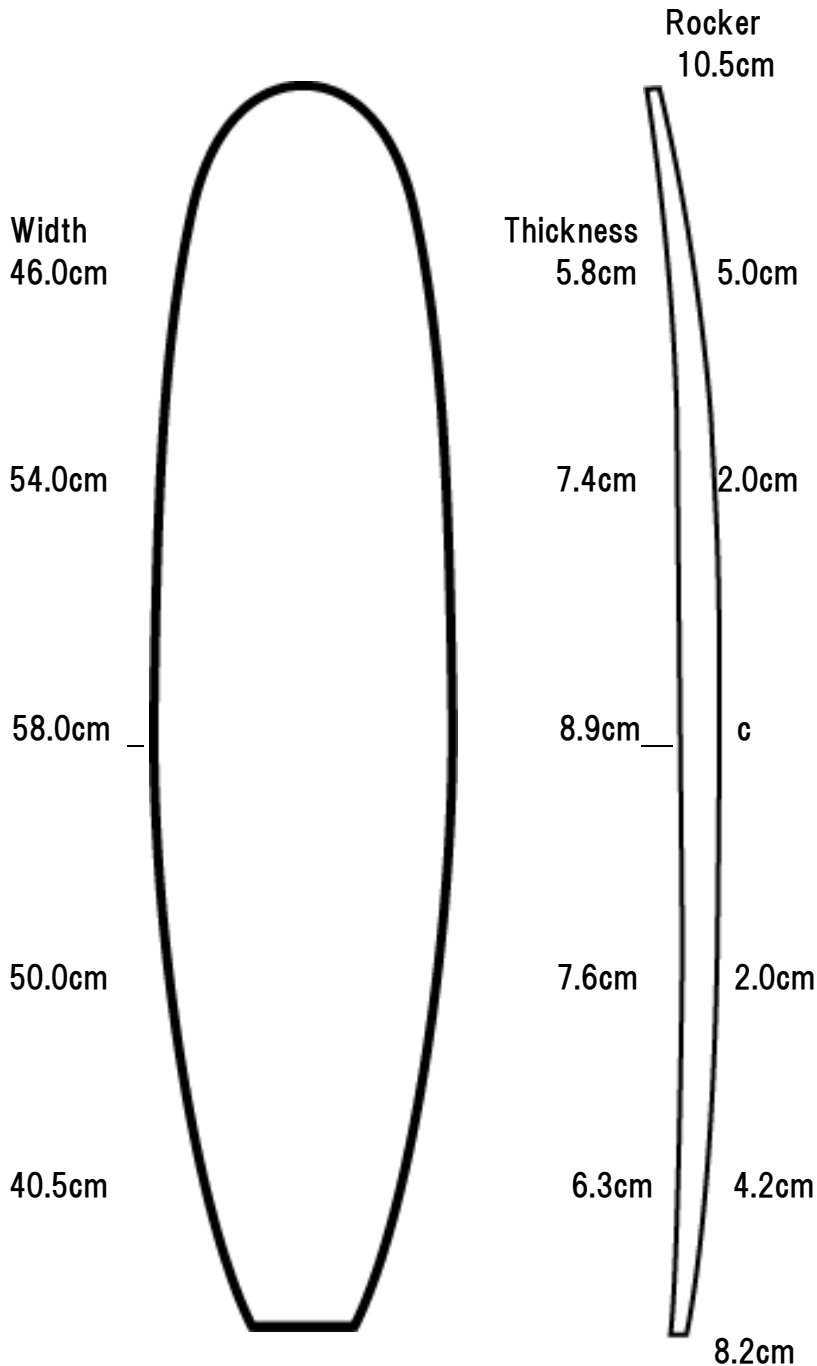

Actual Bottom Length	256.5cm
Max. Width	58.0cm
Max.Thickness	8.9cm
History	2015
Rocker	SKMZ
Weights	SSL
Stringer	1/4 Redwood Multi stringer

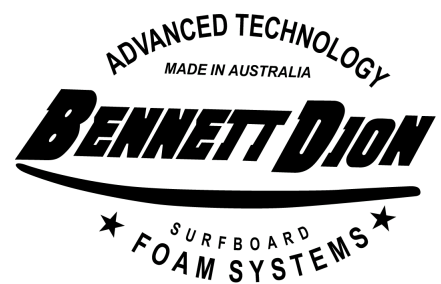

\*数値はあくまで目安参考値

# Longboard Type

# **Bennett-Dion AUST.**

## **Speed Shape Model**

# 9'2"ss

## Performance

## Model

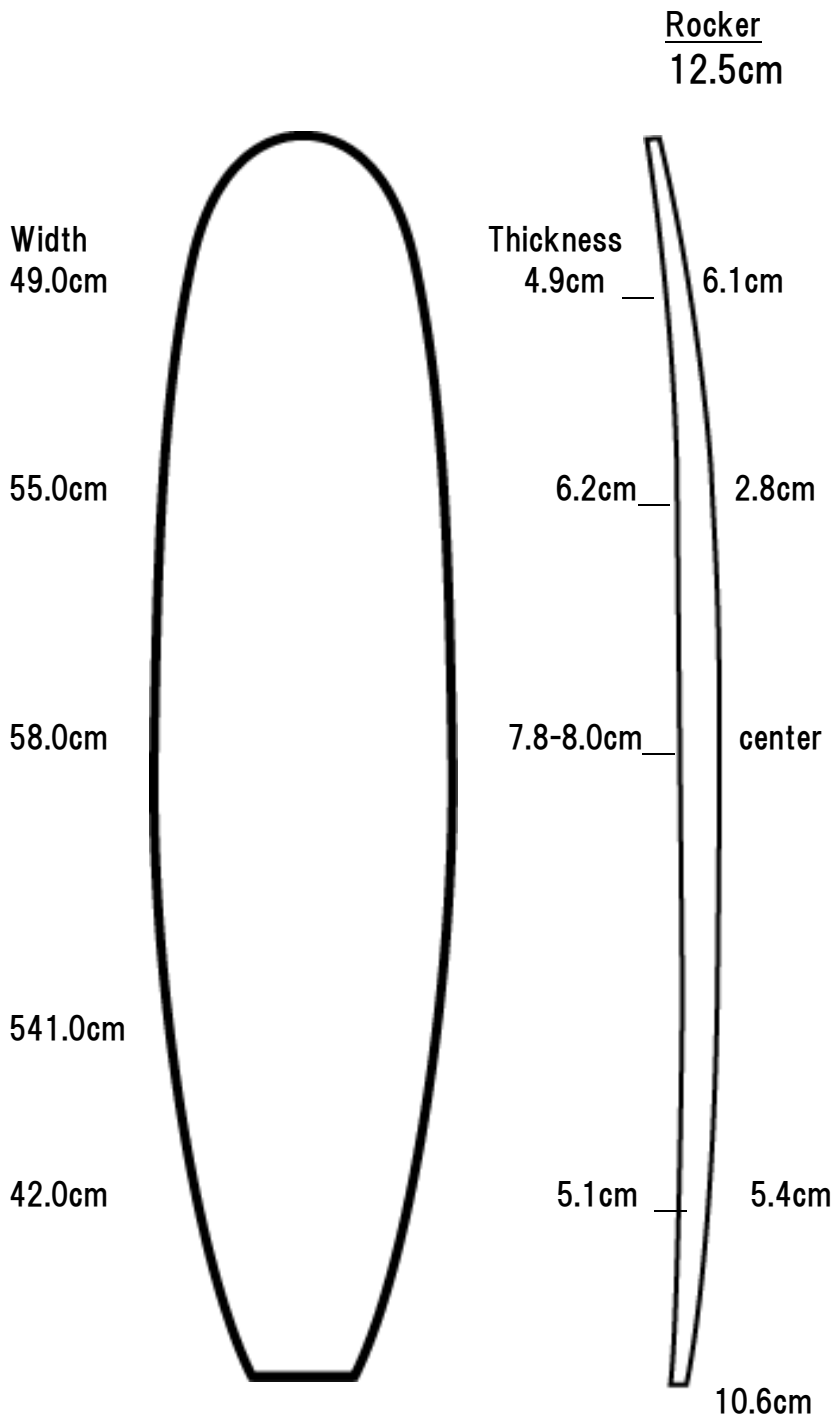

Actual Length	9'2"
Max. Width	Under 58.0cm
Max.Thickness	7.8-8.0cm
History	2009
Rocker	SS
Weights	SSL UL TP
Stringer	1/4

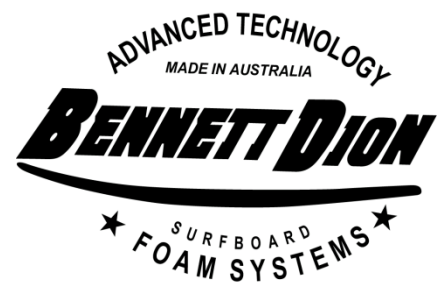

データ数値 個体差あり

high performance model, tail flip

# Bennett-Dion AUSTRALIA

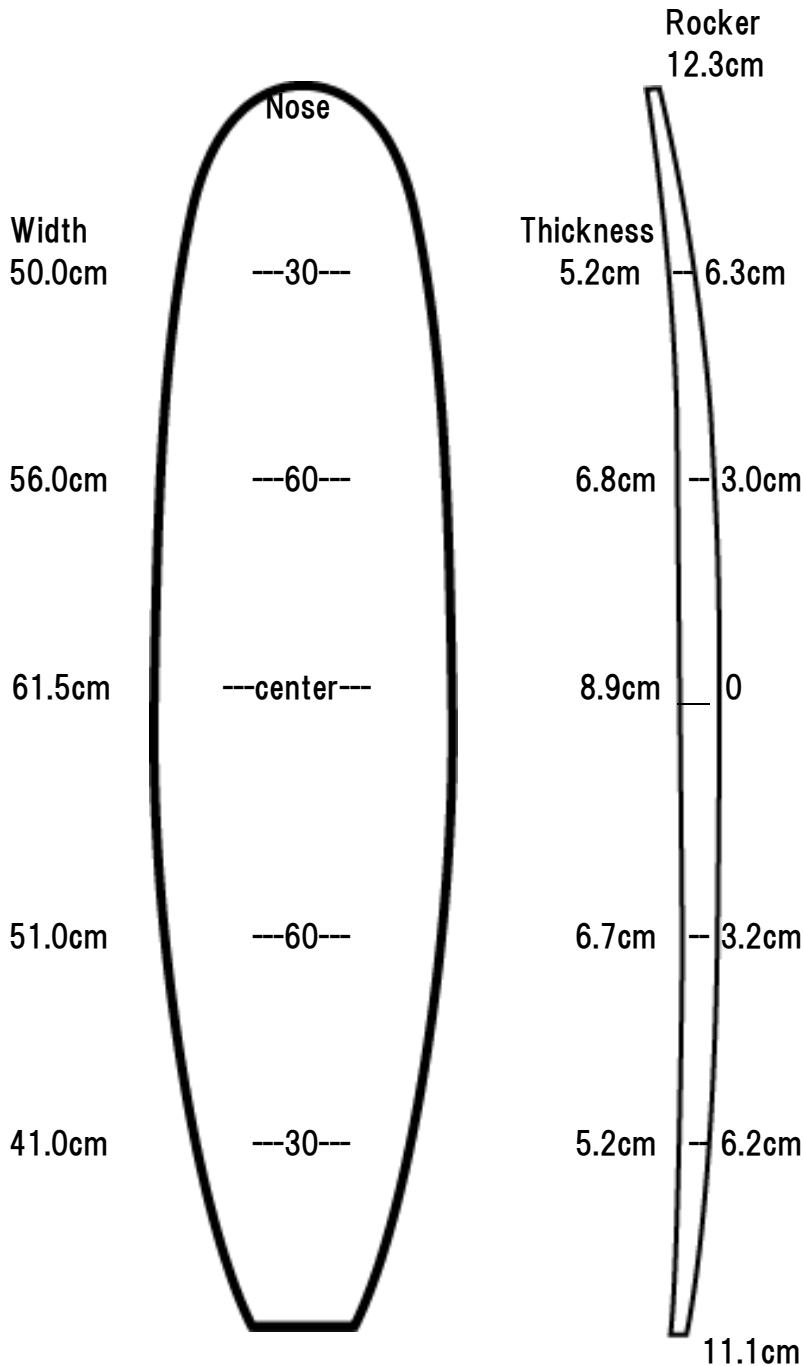

## 9'6<sub>v1</sub> performance

Actual Bottom Length	292.0cm
Max. Width	61.5cm
Max.Thickness	8.9cm
History	2015
Rocker	V1 performance
Weight	Normal
Stringer Variation	Normal Redwood Color Foam multi stringers

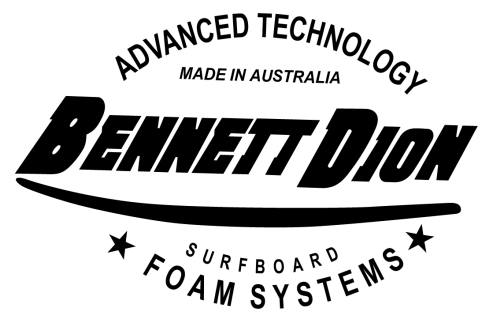

*Newly modern performance design*

\*数値はあくまで目安参考値

# Bennett-Dion AUSTRALIA

## 9'8" AR all-round

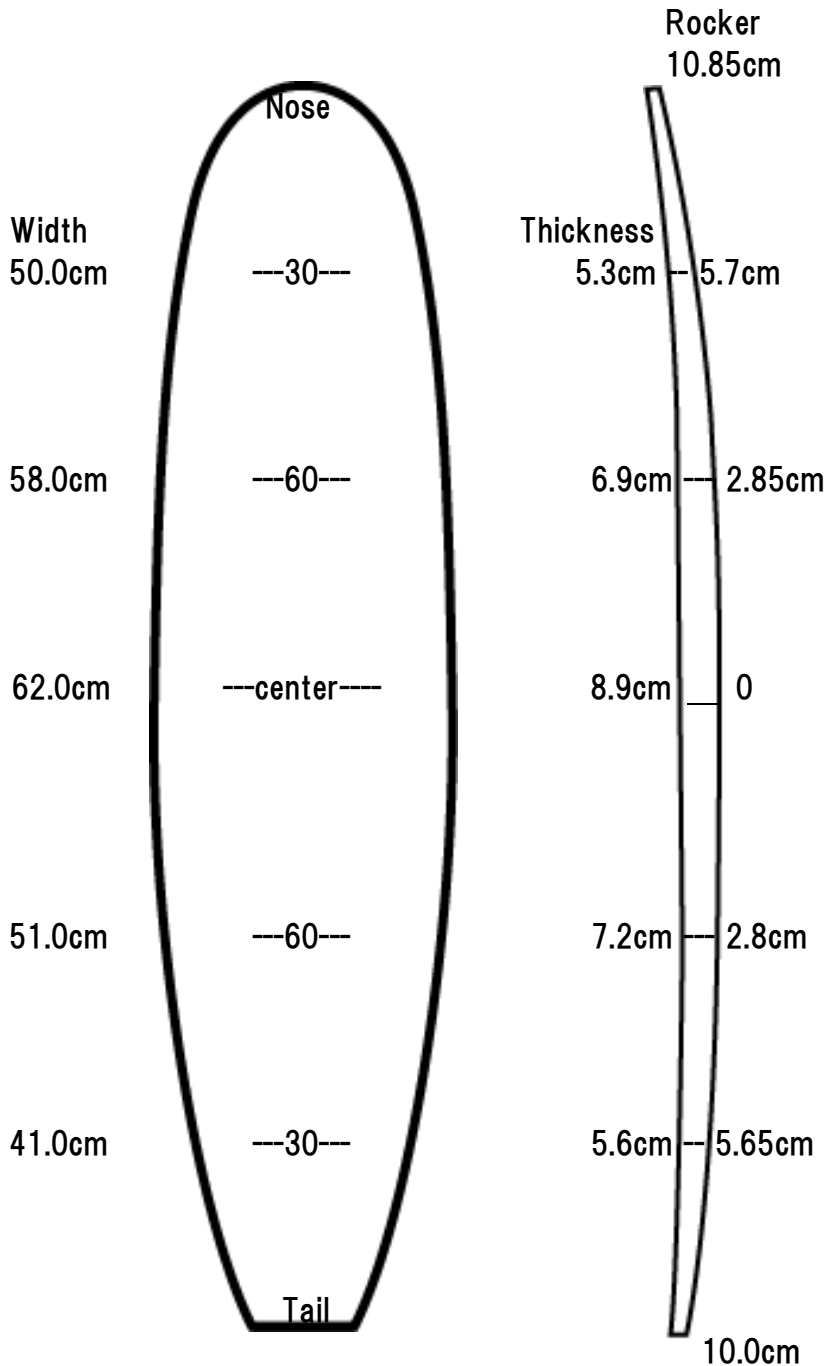

Actual Bottom Length	296.0cm
Max. Width	62.0cm
Max.Thickness	8.9cm
History	2018
Rocker	AR All-Round
Weight	Normal
Stringer Variation	Normal Redwood Color Foam multi stringers

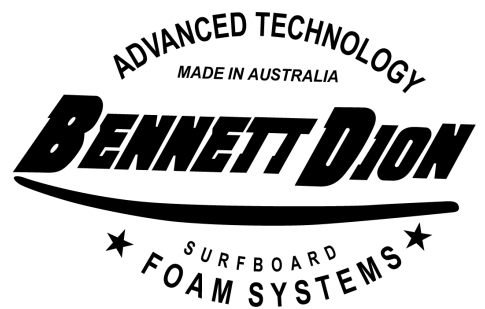

*Newly re-designed curve for all round design c*

\*数値はあくまで目安参考値

# Bennett-Dion AUST.

## 9'8 BB Classic

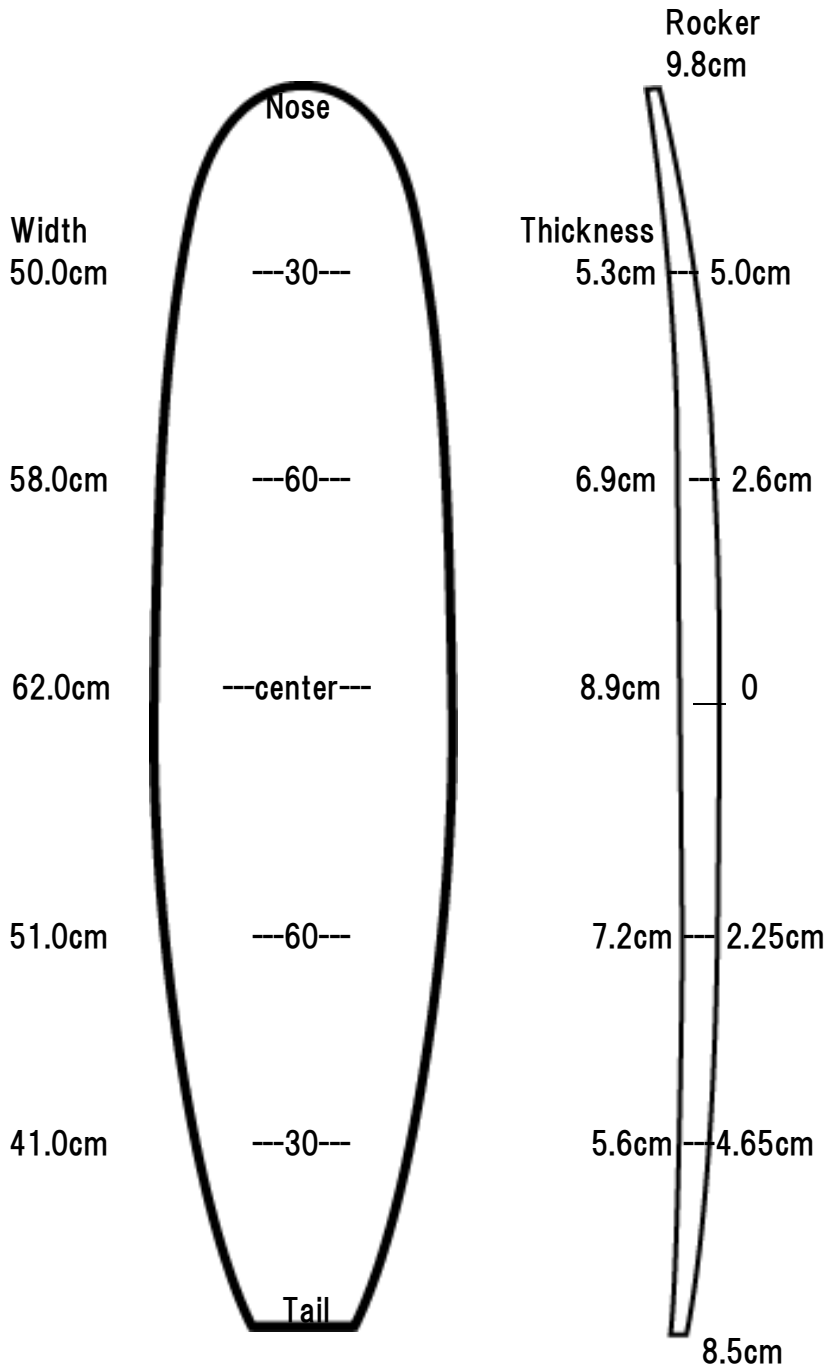

Actual Bottom Length	296.0cm
Max. Width	62.0cm
Max. Thickness	8.9cm
History	2001
Rocker	Barry Bennett
Weight	normal
Stringer	Normal Redwood Color Foam multi stringers

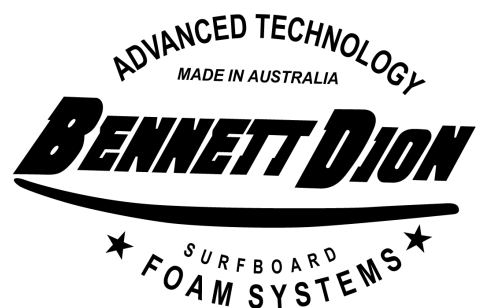

old classic natural curve for noserider



# Bennett-Dion AUST.

# 10'2"

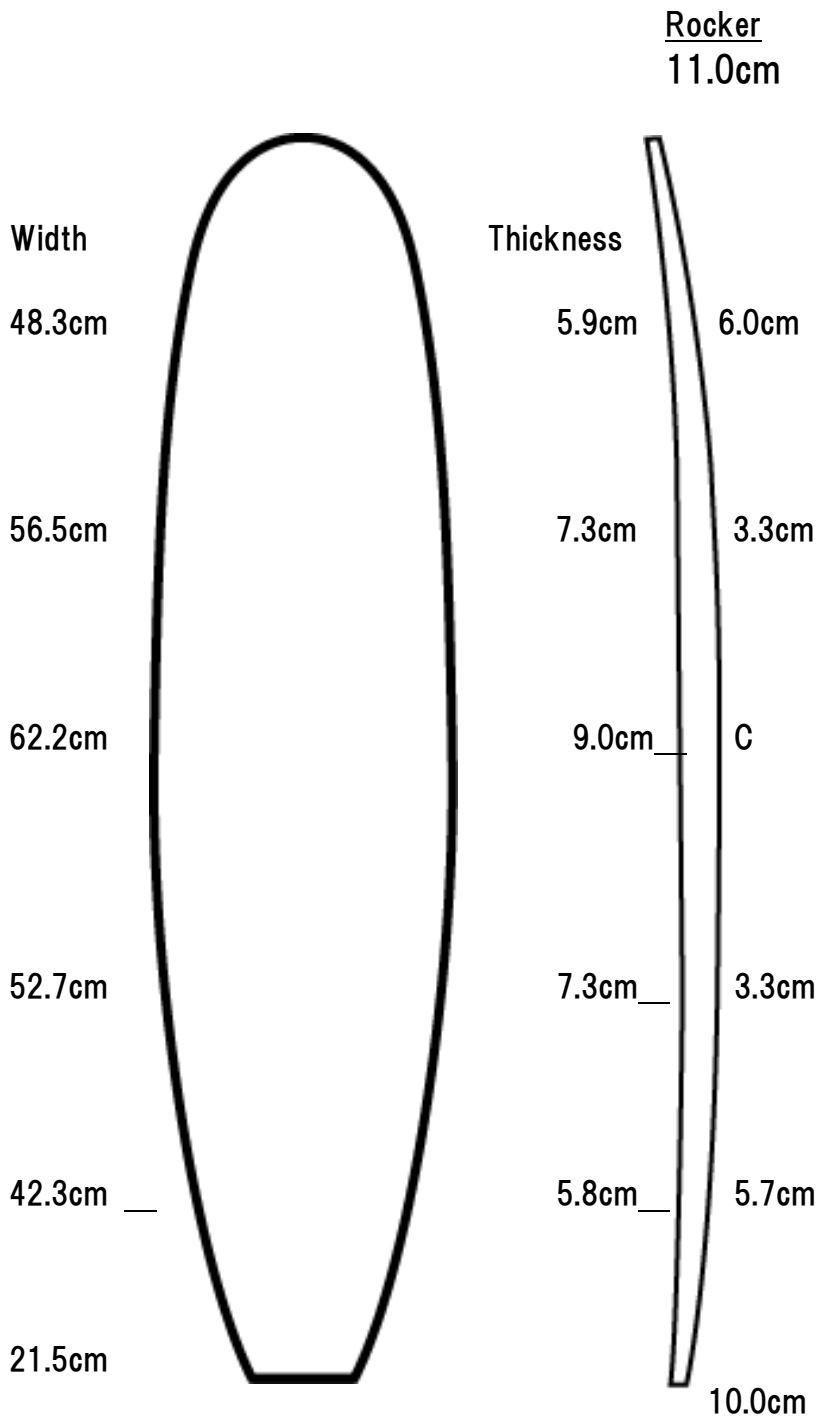

Actual Bottom Length	312.0cm
Max Width	62.2cm
Max Thickness	9.0cm
History	2014
Rocker	BB
Weights	SSL
Stringer	

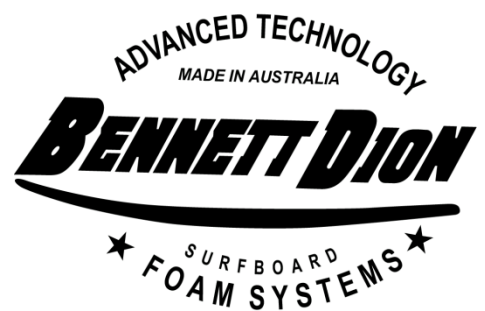

数値はあくまで目安参考値

EPSS

# Bennett-Dion EPS Foam System

## EPS 6'7 DD

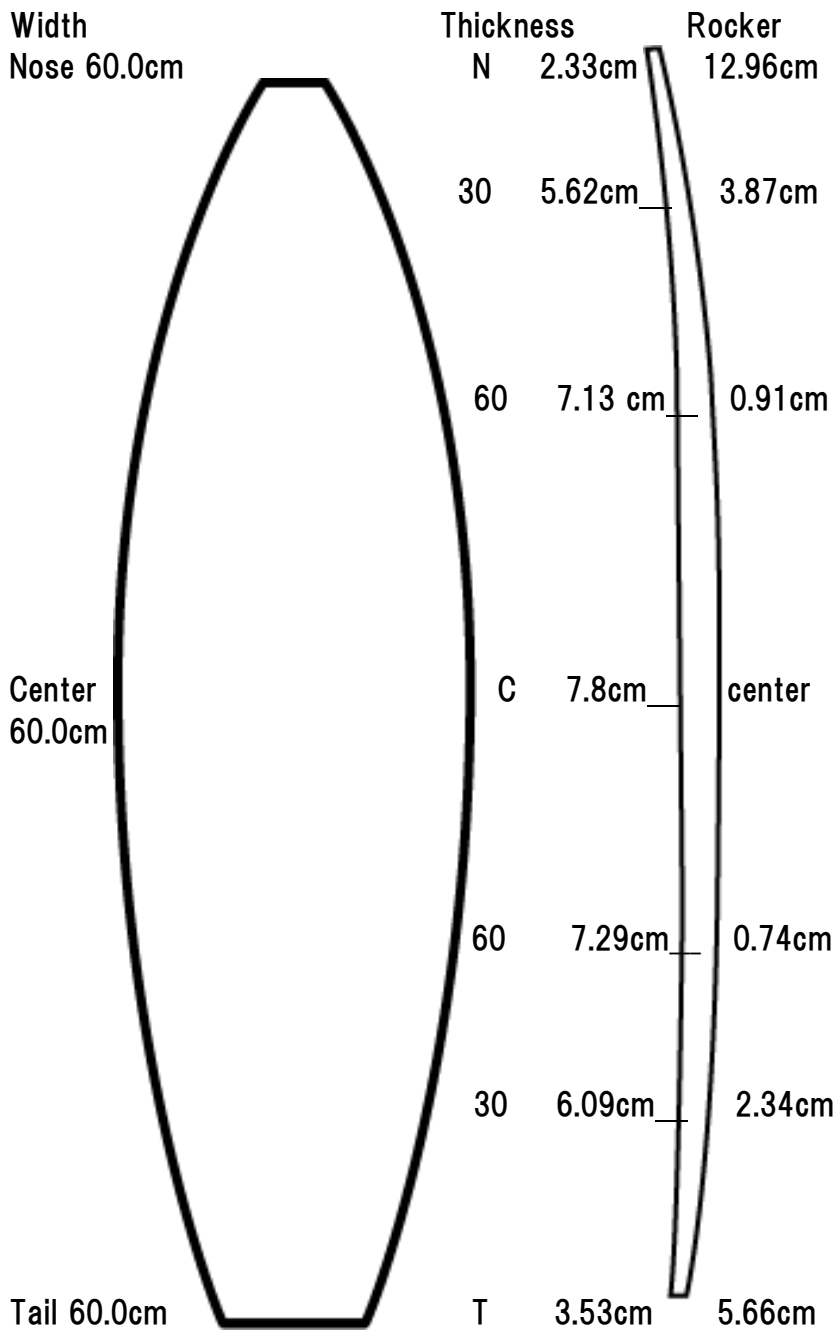

Deck Length	201cm
Max. Width	60.0cm
Max.Thickness	7.8cm
History	2016
Rocker	DD
Weights	x40 · x 30
Stringer	1/8 No stringer

\*数値はあくまで参考値

# Bennett-Dion EPS Foam System

## EPS 6'7 FR

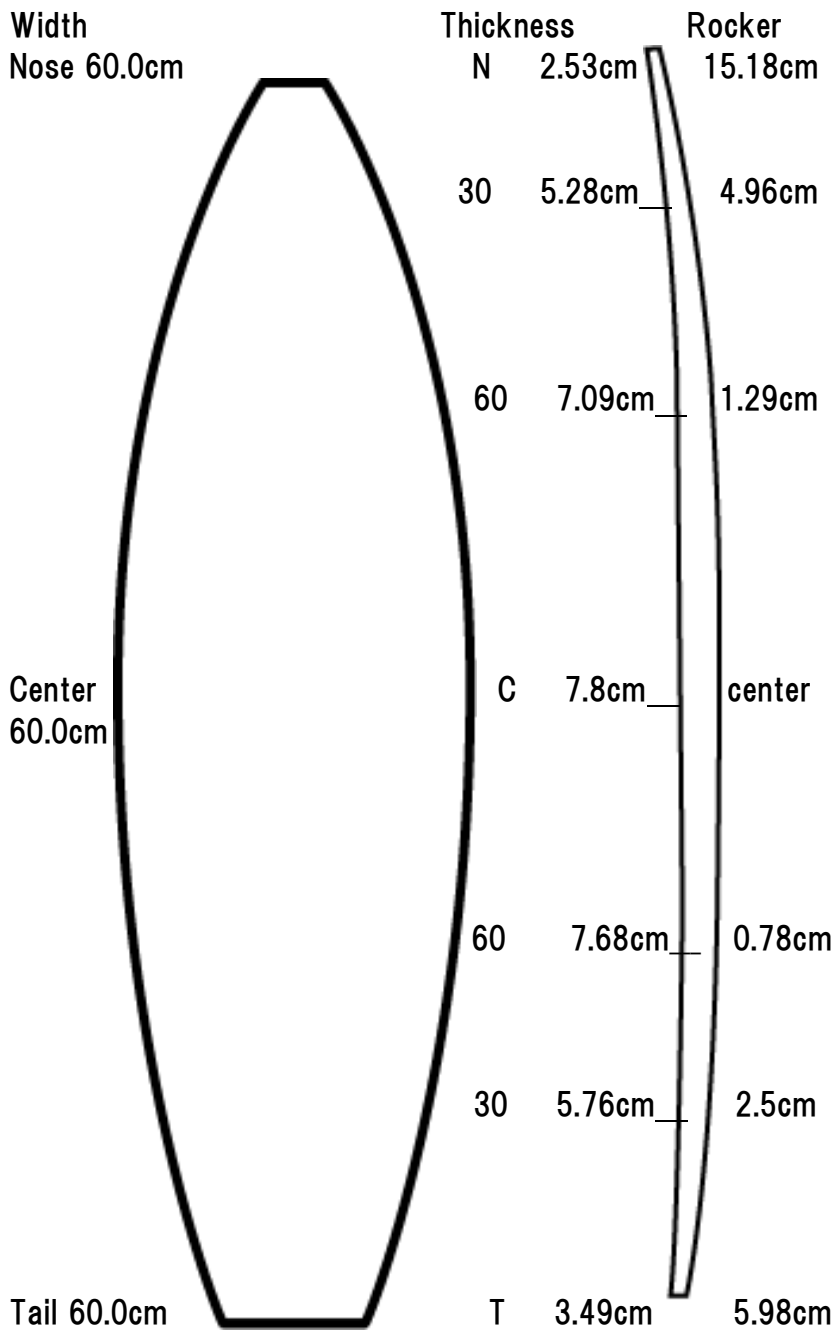

Deck Length	201cm
Max. Width	60.0cm
Max.Thickness	7.8cm
History	2016
Rocker	FR
Weights	x40 · x30
Stringer	1/8 No stringer

\*数値はあくまで参考値

# Bennett-Dion EPS

## EPS 9'4

### V1 Performance

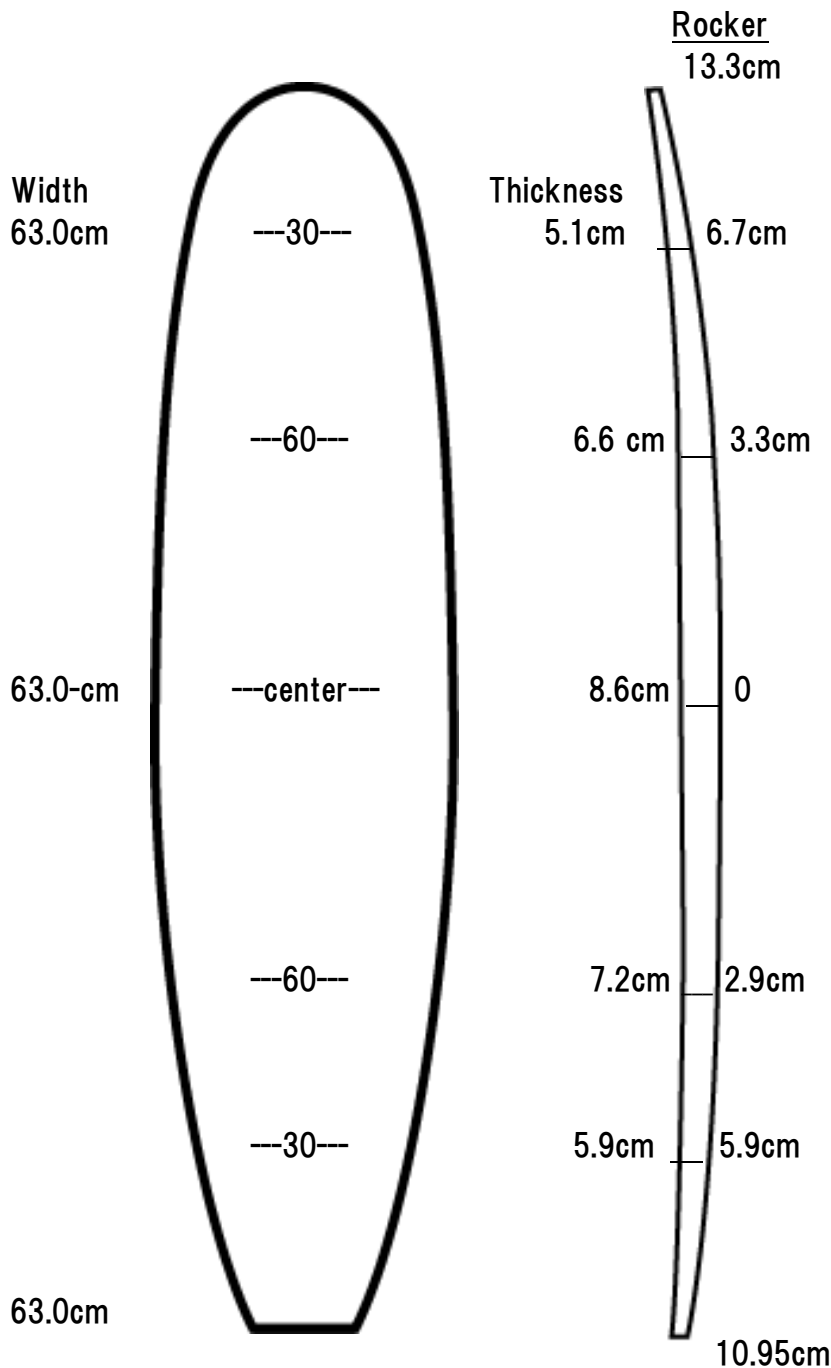

Actual Length	Deck	285.0cm
		9'4"
Max. Width		63.0cm
Max.Thickness		8.6cm
		Extra Fat
History		2018
Rocker		V1
Weight		normal
Stringer		ASK

\* 数値はあくまで目安の参考値

# Bennett-Dion EPS

## EPS 9'4

### V2 all-round

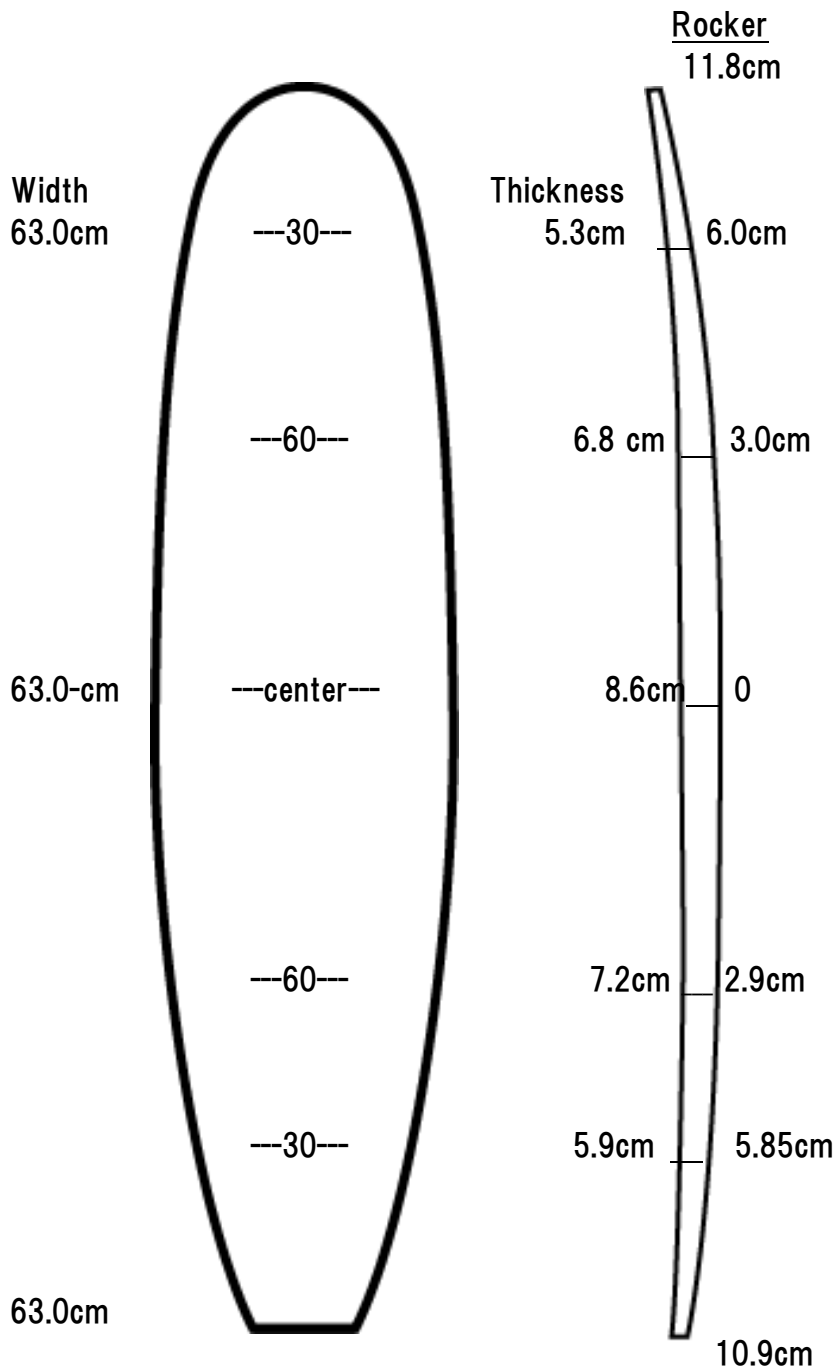

Actual Length	Deck	285.0cm
		9'4"
Max. Width		63.0cm
Max.Thickness		8.6cm
		Extra Fat
History		2018
Rocker		V2
Weight		normal
Stringer		ASK

\* 数値はあくまで目安の参考値

# Bennett-Dion EPS

## EPS 9'4

### V3 classic

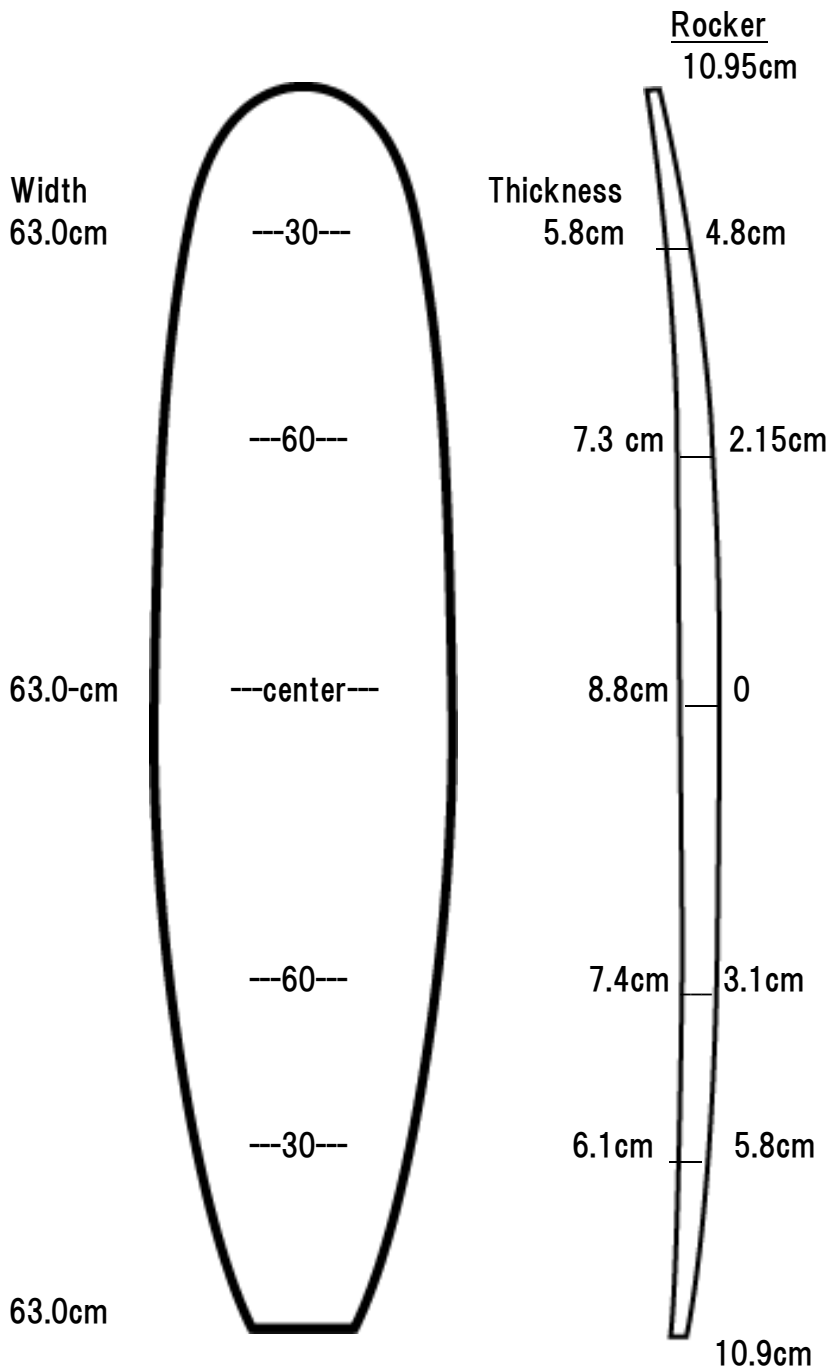

Actual Length	Deck	285.0cm
		9'4"
Max. Width		63.0cm
Max.Thickness		8.8cm
		Extra fat
History		2019
Rocker		V3
Weight		normal
Stringer		ASK

\* 数値はあくまで目安の参考値

**EPS**

# EPS 10'1''

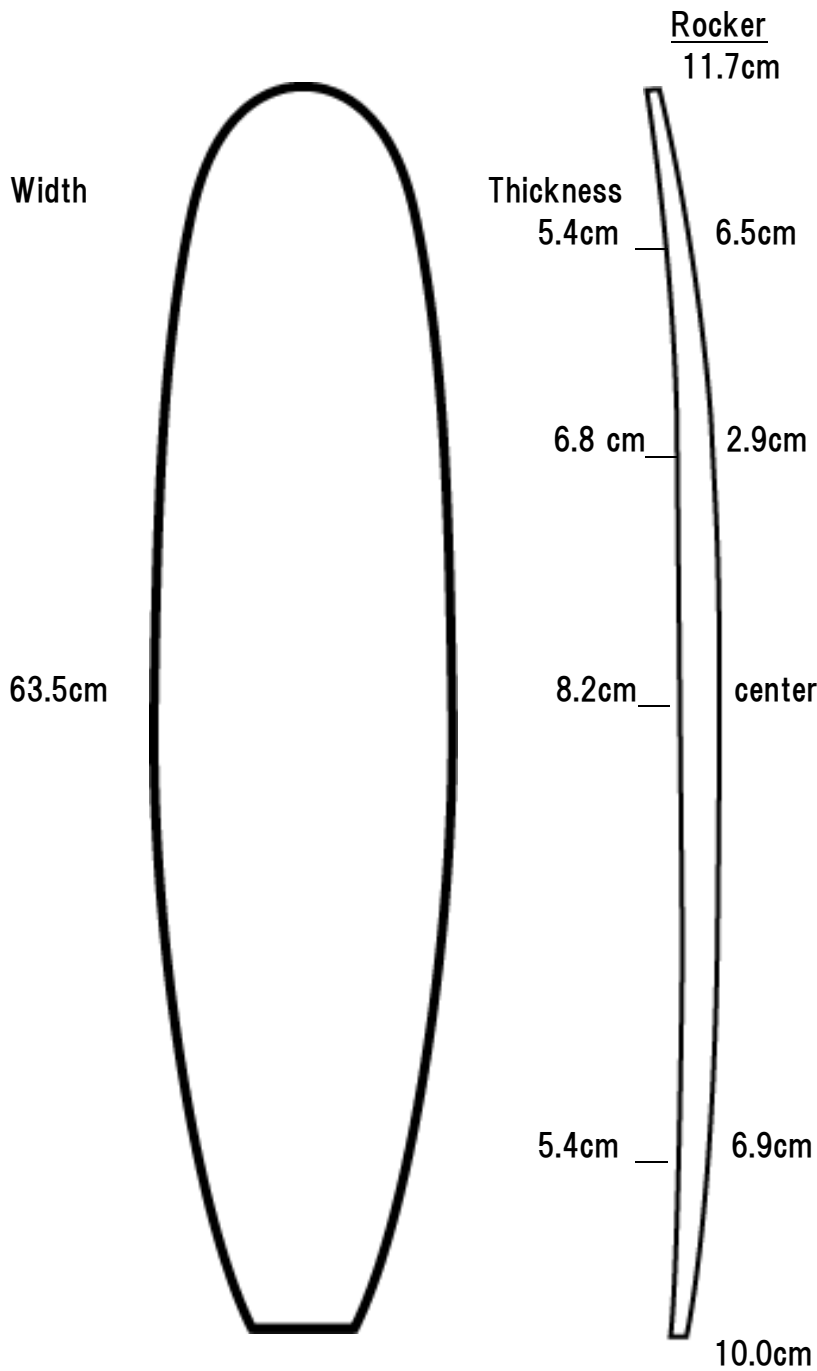

<b>Actual Length</b>	
<b>Max. Width</b>	
<b>Max.Thickness</b>	<b>63.5cm</b>
<b>History</b>	<b>2011</b>
<b>Rocker</b>	
<b>Weights</b>	<b>x40</b>
<b>Stringer</b>	<b>1/4</b>

データ数値 個体差あり