

ADVANCED TECHNOLOGY  
MADE IN AUSTRALIA

**BENNETT DION**

★ SURFBOARD  
FOAM SYSTEMS ★

# Shortboard Type

# Bennett-Dion AUST.

## Speed Shape Model

# 5'11"FRSS

Rocker 13.45cm

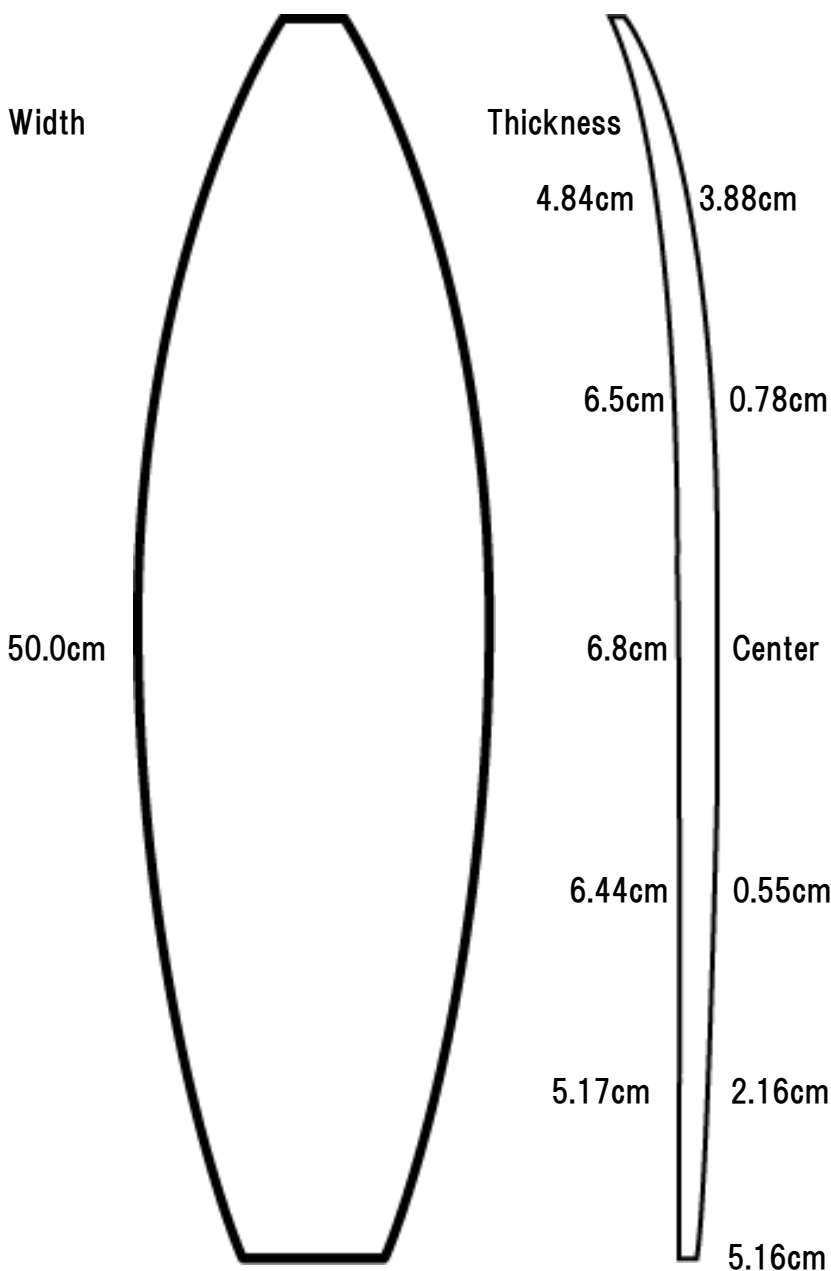

Deck Length	5'11
Max. Width	50cm
Max.Thickness	6.8 cm~
History	2016
Rocker	FR
Weights	UL
Stringer	1/8

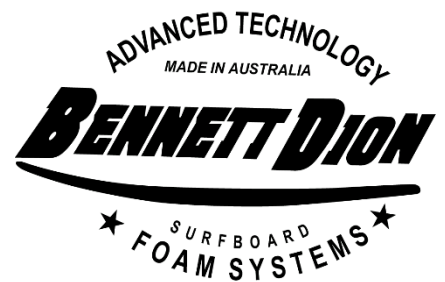

データ数値はあくまで参考値

\*アウトラインはカットされておりません (使用フォームによりアウトライン異なります)

Performance to all-rounder

# **Bennett-Dion AUST.**

## **Speed Shape Model**

# 6'2"FRSS

Rocker 14.01cm

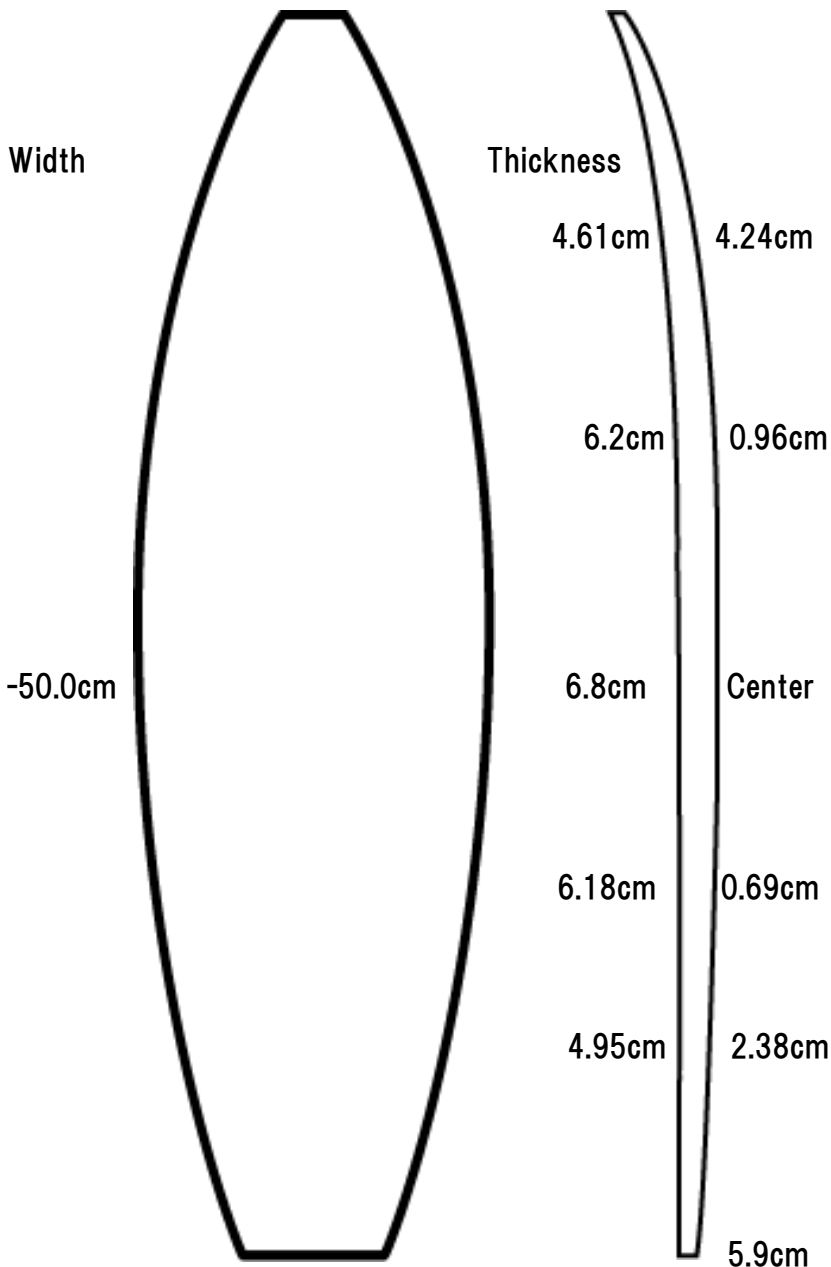

Deck Length	6'2
Max. Width	50cm
Max.Thickness	6.8 cm~
History	2016
Rocker	FR
Weights	UL
Stringer	1/8

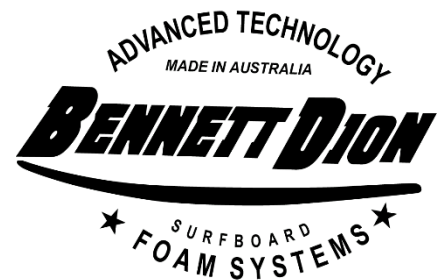

データ数値はあくまで参考値

\*アウトラインはカットされておりません (使用フォームによりアウトライン異なります)

*for performance or all-rounder*

 **Peak of Japan**

# Bennett-Dion AUST.

## 6'4''-D10

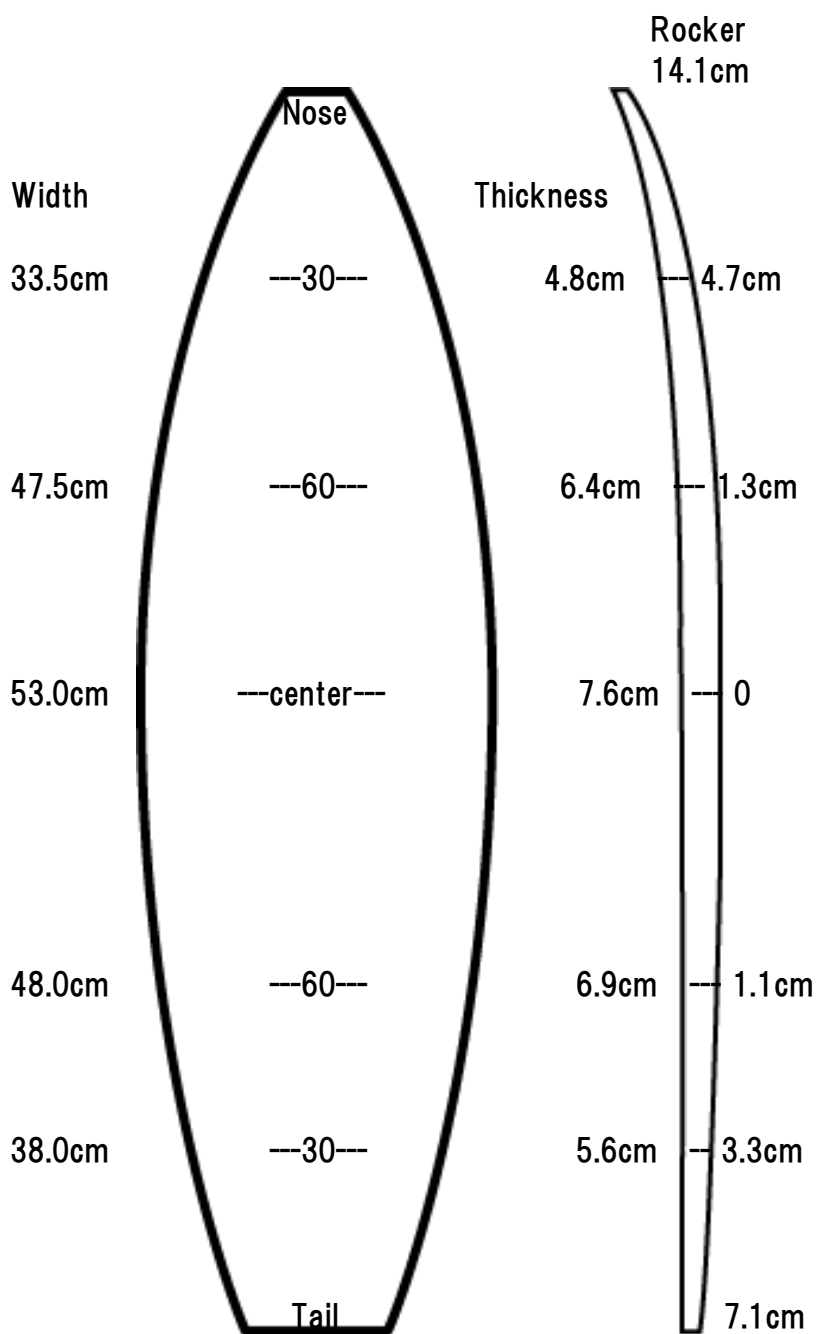

Bottom Length	198cm
Max. Width	53.0cm
Max. Thickness	7.6cm
History	2019
Rocker	D10
Weights	UL Team Pro
Stringer	1/8

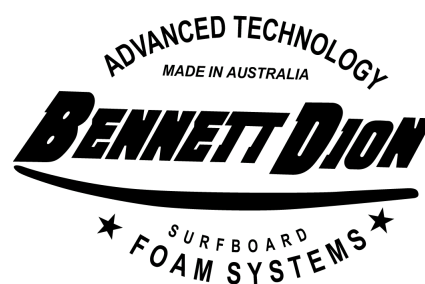

\*数値はあくまで目安の参考値

# Bennett-Dion AUST.

## 6'4-D19

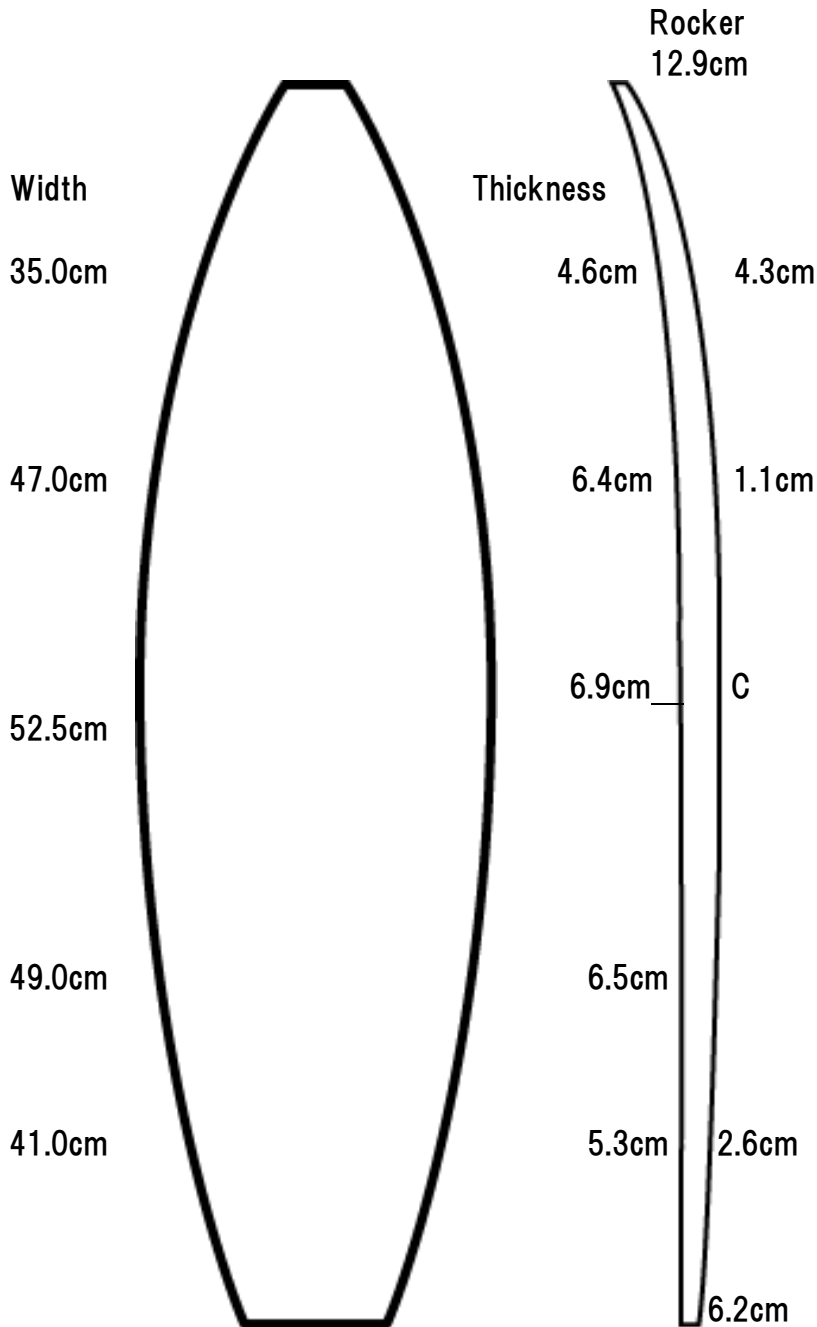

<b>Bottom Length</b>	195cm
<b>Max. Width</b>	52.5cm
<b>Max. Thickness</b>	6.9cm
<b>History</b>	2013
<b>Rocker</b>	671010
<b>Weights</b>	UL Team Pro
<b>Stringer</b>	1/8

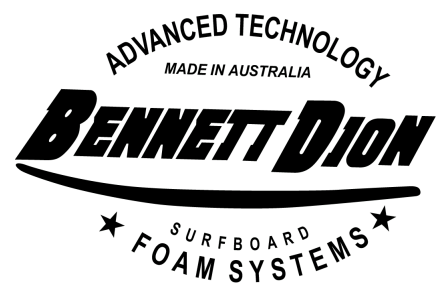

*for performance or all-rounder  
natural and versatile curve  
applied to 6'7 plug*

# Bennett-Dion AUST.

## 6'4-mor

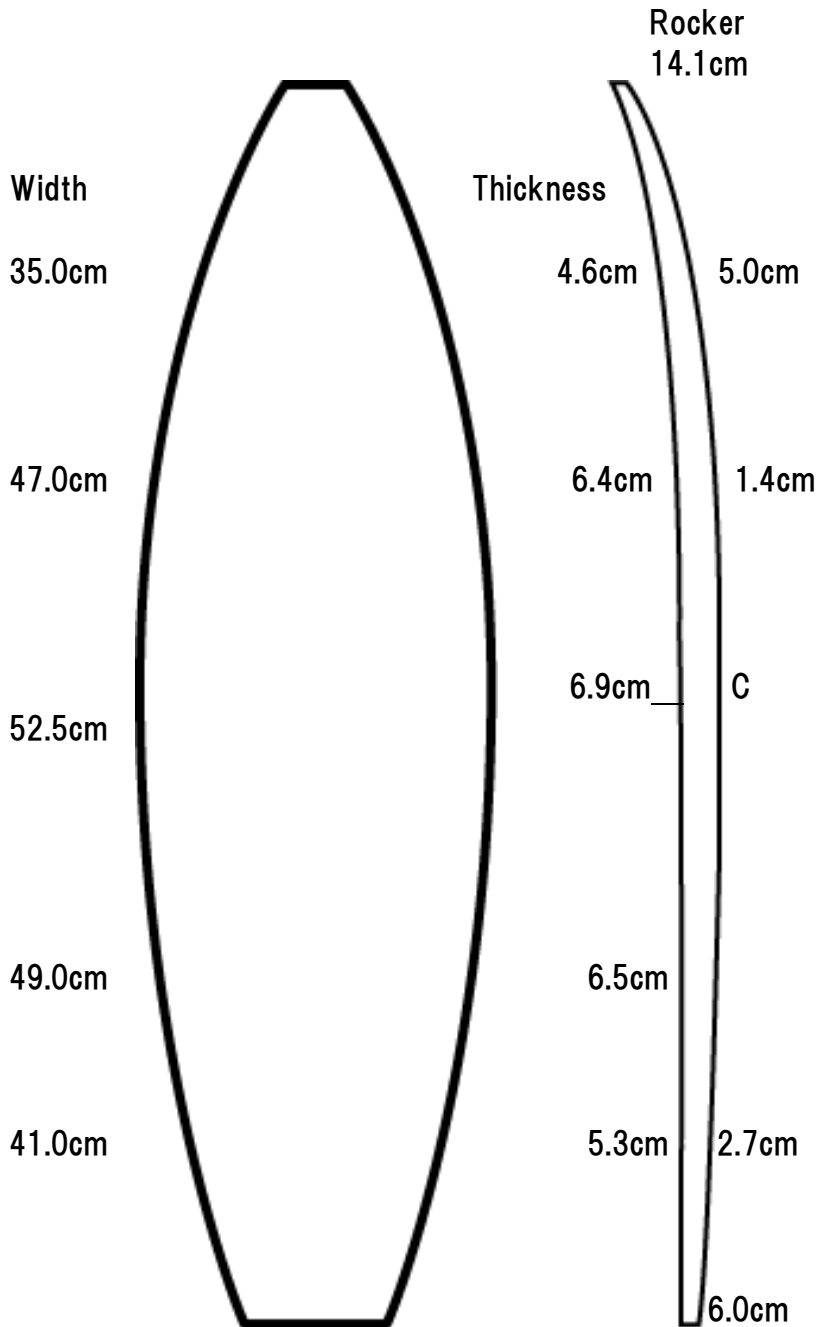

Bottom Length	195cm
Max. Width	52.5cm
Max. Thickness	6.9cm
History	2014
Rocker	67mor
Weights	UL Team Pro
Stringer	1/8

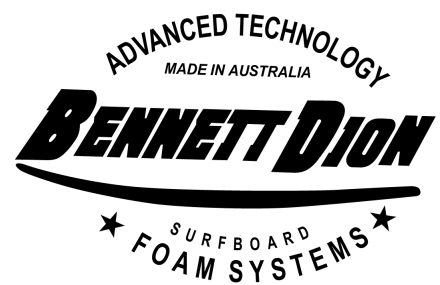

*Curvy rocker for performance or all-rounder  
Full model change from 6'4D3 model  
applied to 6'7 plug*

# Bennett-Dion AUST.

# 6'7" D47

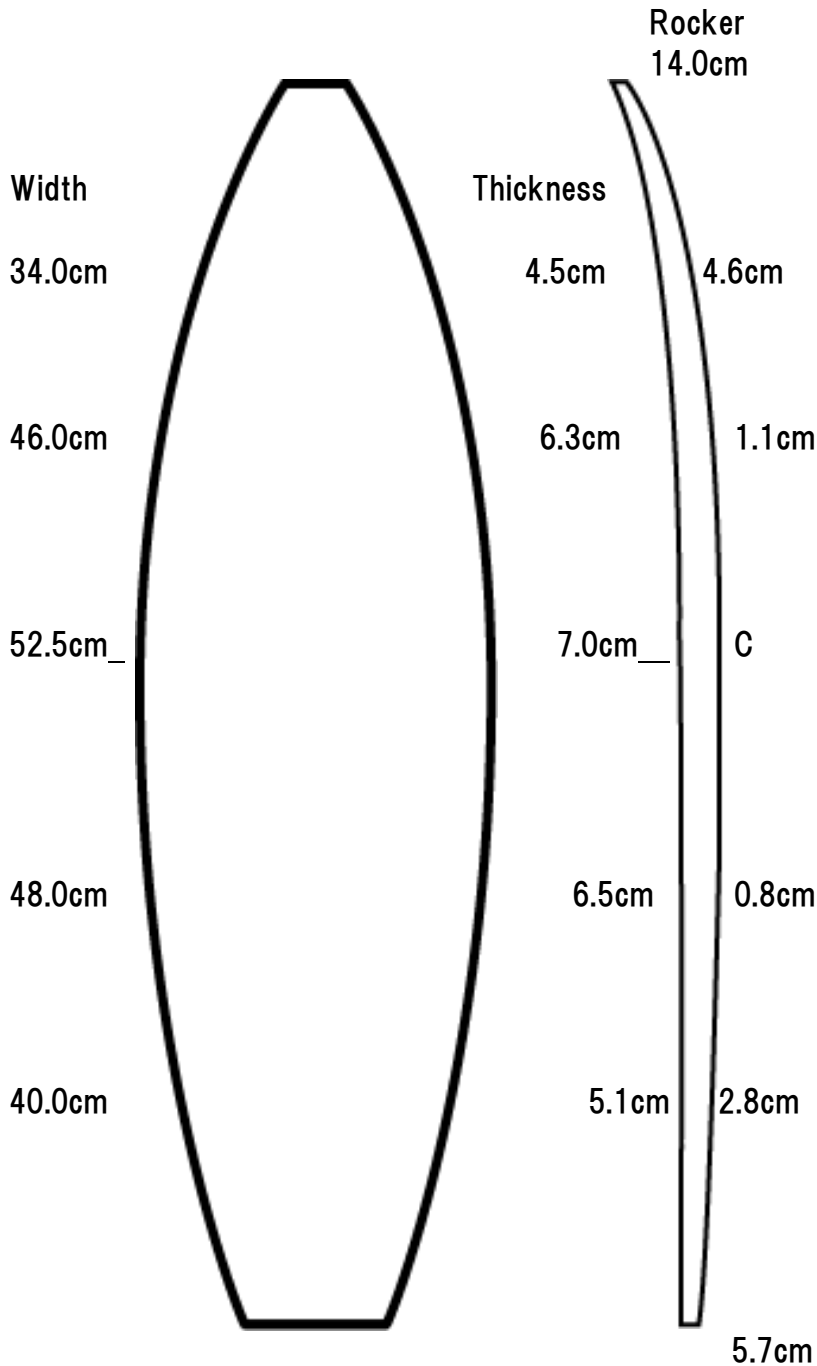

Actual Bottom Length	203.5cm
Max Width	52.5cm
Max Thickness	7.0cm
History	2013
Rocker	POJ4
Weights	UL
Stringer	1/8

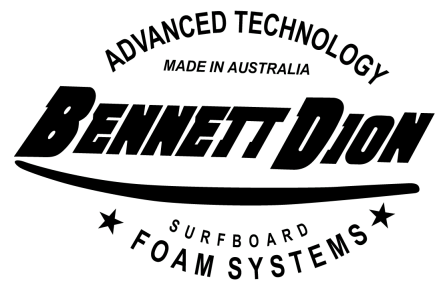

*for performance or all-rounder*

\*数値はあくまで目安参考値



# Bennett-Dion AUST.

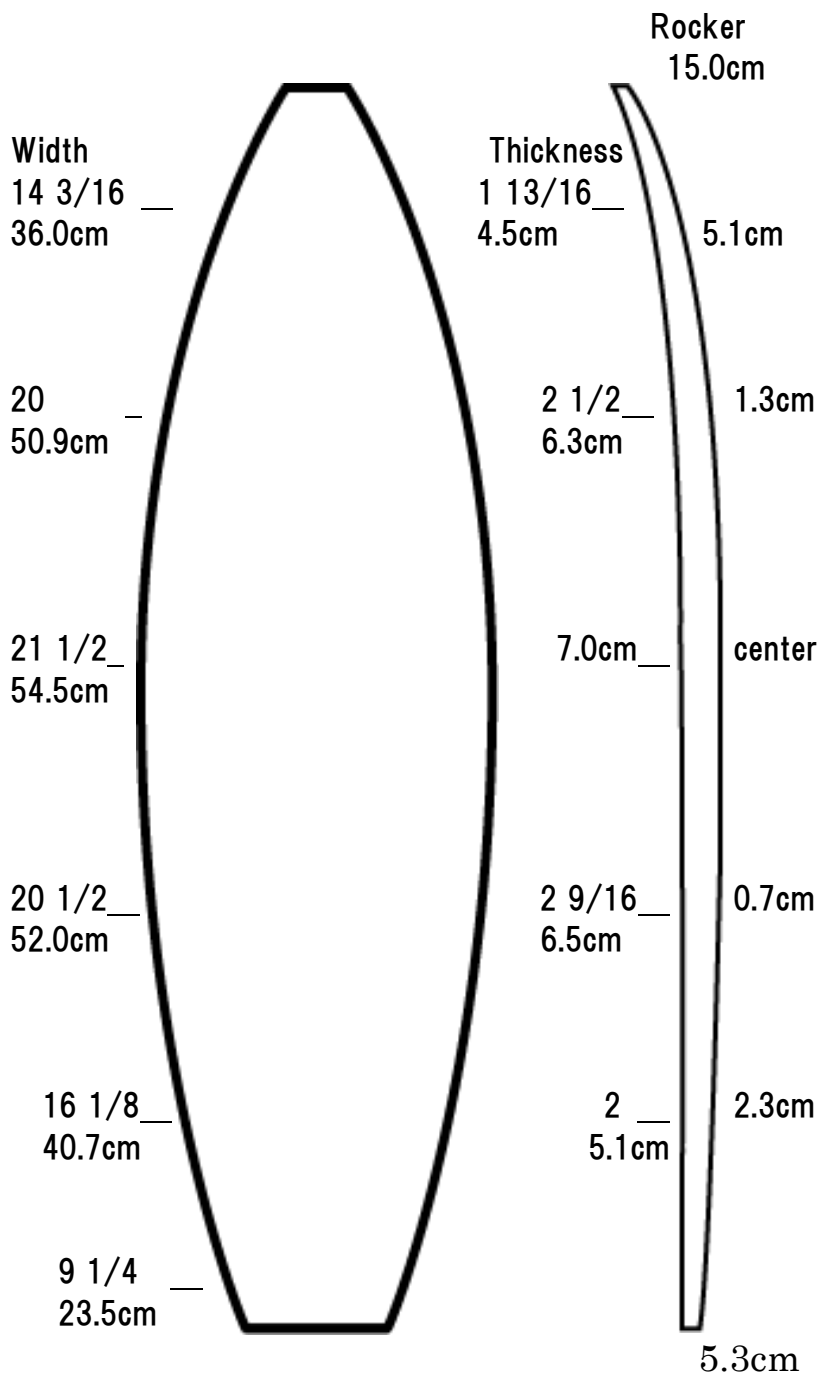

# 6'7"

## D69

Actual Length	6'07" 202.1cm
Maximum Width	21 1/2 54.5cm
Maximum Thickness	7.0cm
History	1997
Rocker	D69
Weights	UL Team Rider
Stringer	1/8

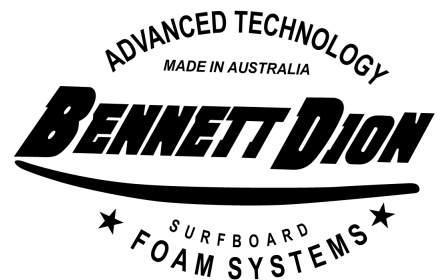

*originally designed for profile machine cut  
nose flip kind curve*

# ***Bennett-Dion AUST.***

## ***6'7 Thick SPR rocker***

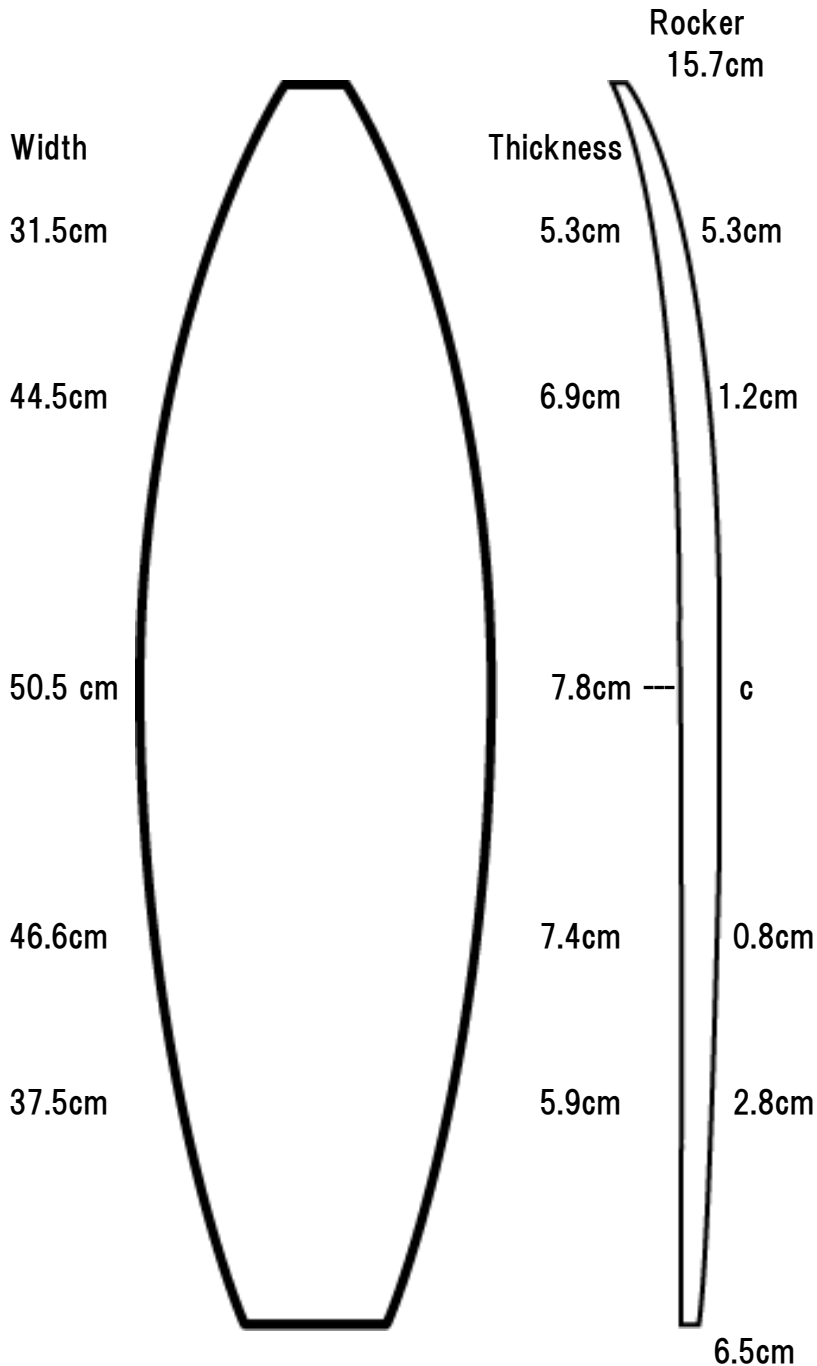

<b>Actual Bottom Length</b>	<b>203cm</b>
<b>Max. Width</b>	<b>50.5cm</b>
<b>Max.Thickness</b>	<b>7.8cm</b>
<b>History</b>	<b>2014</b>
<b>Rocker</b>	<b>SPR</b>
<b>Weights</b>	<b>UL</b>
<b>Stringer</b>	<b>1/8</b>

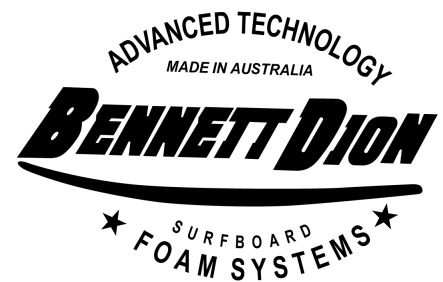

*Thicker version of 6'7  
Suitable for both hand shaping and profile machine cut  
Tail kick version of 6'7-D69 model*

# **Bennett-Dion AUST.**

## **6'7 Thick D69 rocker**

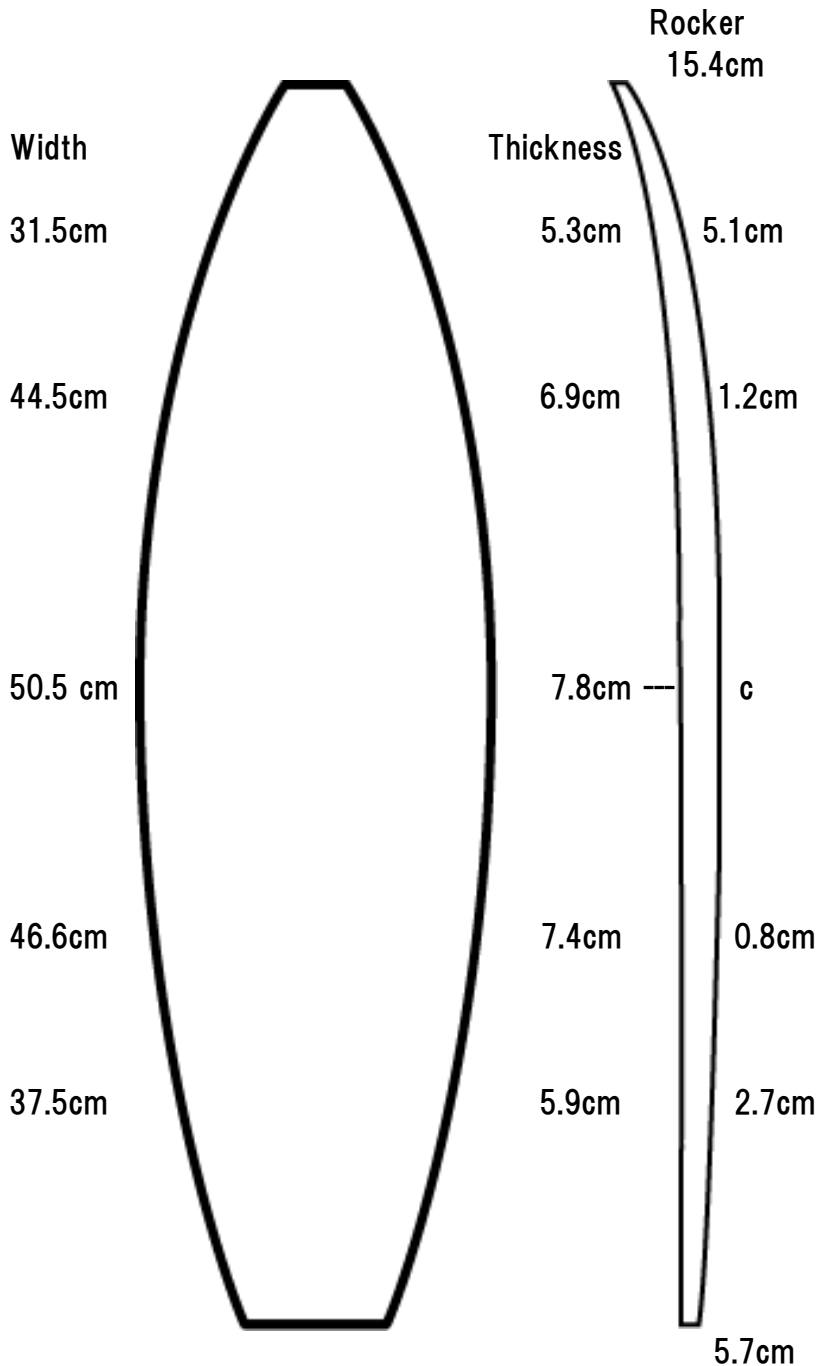

<b>Actual Bottom Length</b>	<b>203cm</b>
<b>Max. Width</b>	<b>50.5cm</b>
<b>Max.Thickness</b>	<b>7.8cm</b>
<b>History</b>	<b>2014</b>
<b>Rocker</b>	<b>D69</b>
<b>Weights</b>	<b>UL</b>
<b>Stringer</b>	<b>1/8</b>

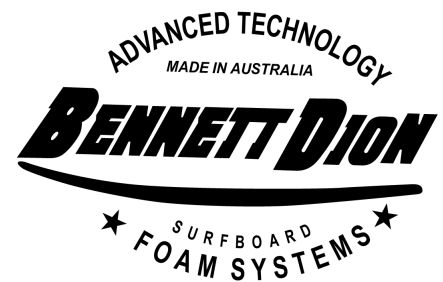

*Thicker version of 6'7  
Suitable for both hand shaping and profile machine cut*

# Bennett-Dion AUST.

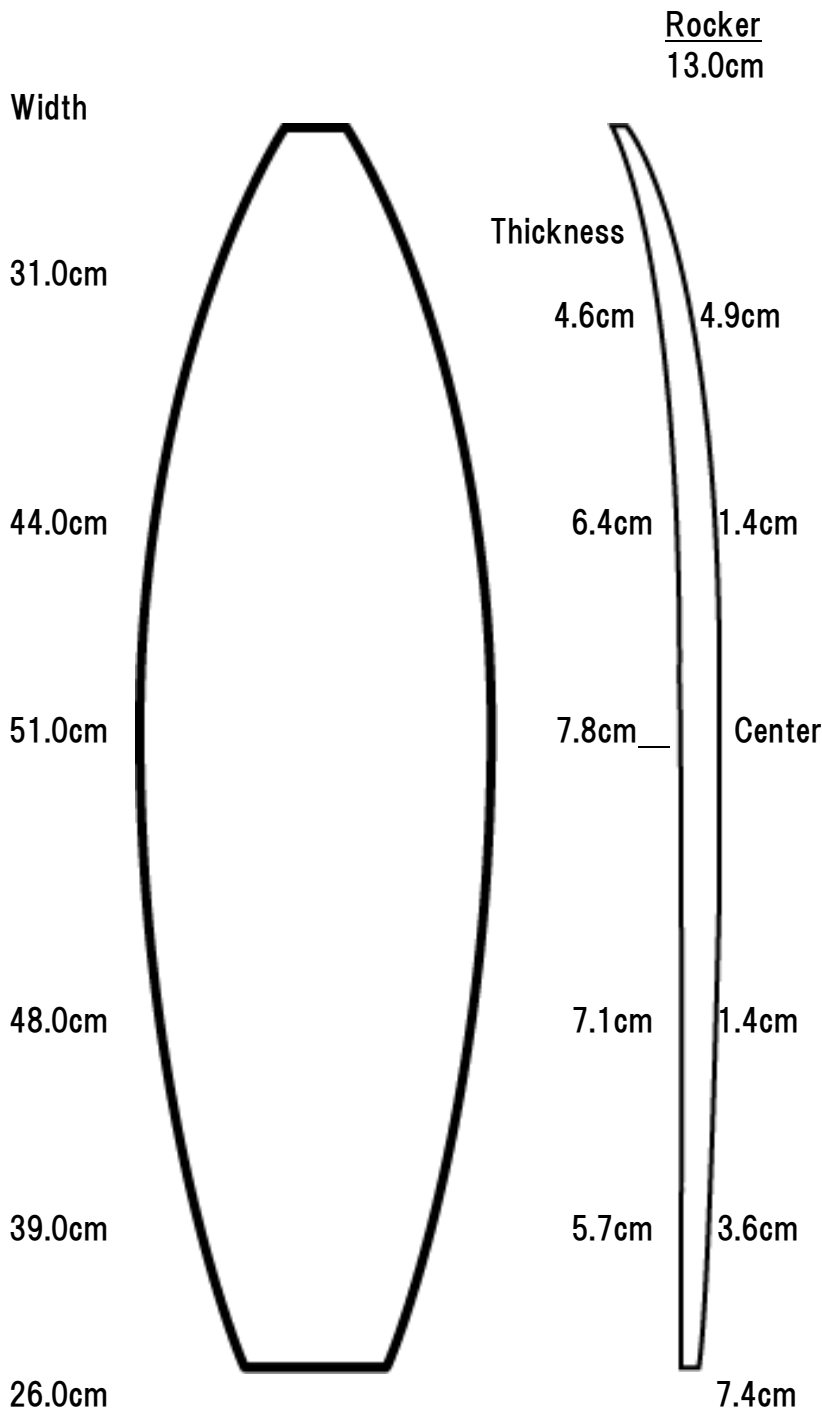

# 6'10"

Actual Bottom Length	212.0 cm
Max.Width	51.0cm
Max.Thickness	7.8cm
History	2014
Rocker	702-mor
Weights	SSL UL
Stringer	1/8 1/4 Redwood

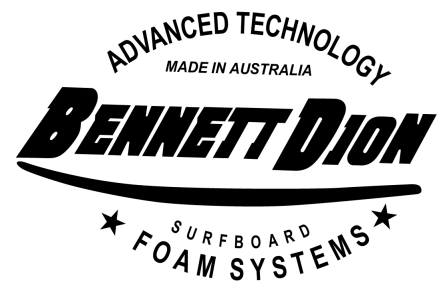

4inches chopped off tail from 7'2 plug  
for all-rounder  
adjustable to narrower mini-boards

# Bennett-Dion AUST.

## 6'10 Fat spr rocker

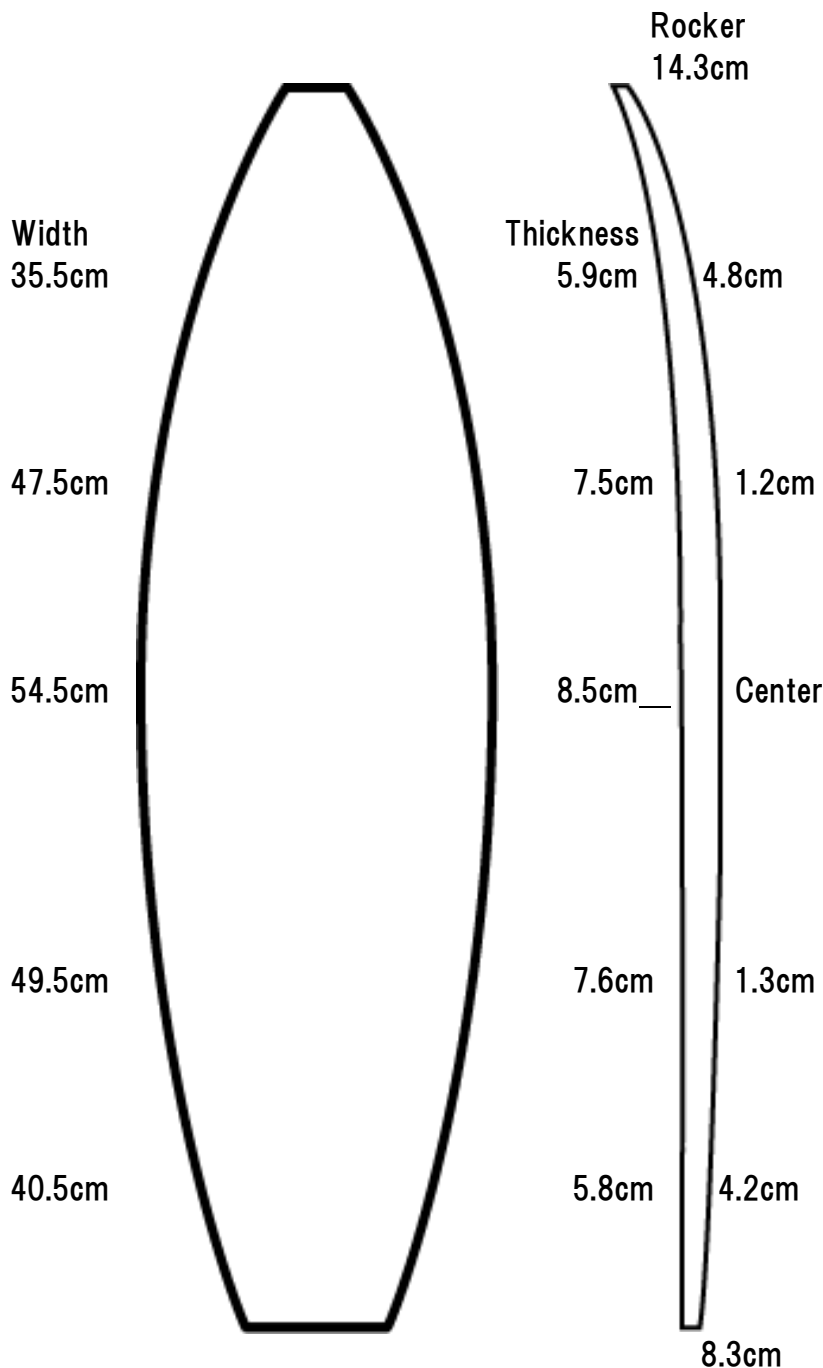

Actual Bottom Length	212.5 cm
Max.Width	54.5cm
Max.Thickness	8.5cm
History	2014
Rocker	SPR
Weights	UL
Stringer	1/8

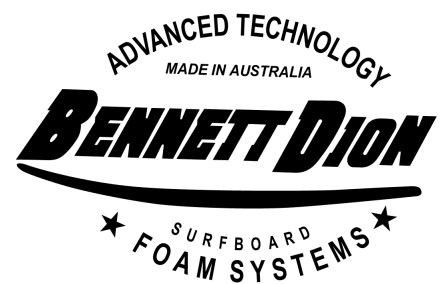

*Newly released plug in late 2014  
For all-round, mini, fish, retro, fatter models or whatever....  
Also machine profile cut friendly*

# Bennett-Dion AUST.

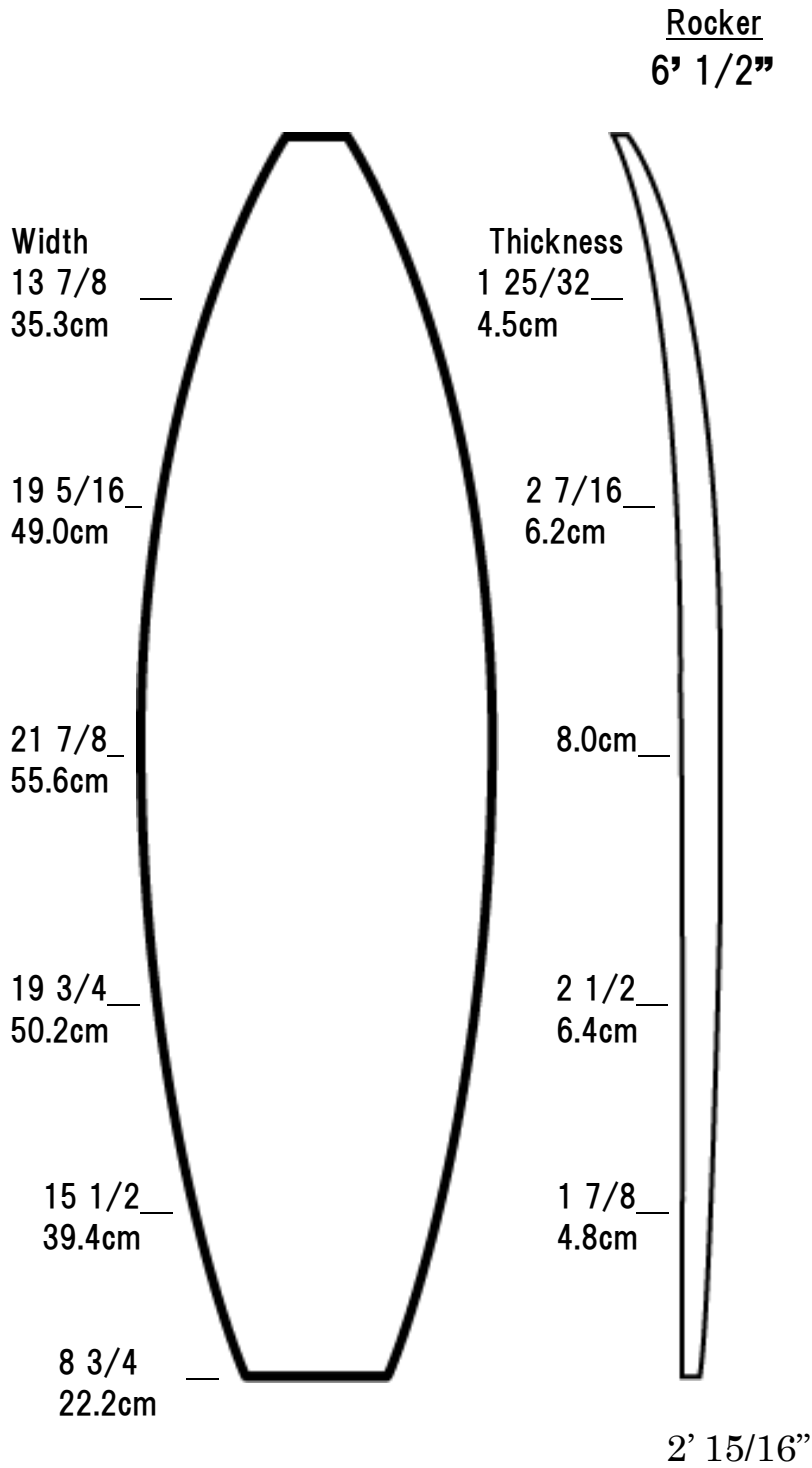

**7'2"**  
**D3**

Actual Length	7'02" 210.3cm
Maximum Width	21 7/8 55.6cm
Maximum Thickness	8.0cm
History	1998
Rocker	D3
Weights	SSL
Stringer	

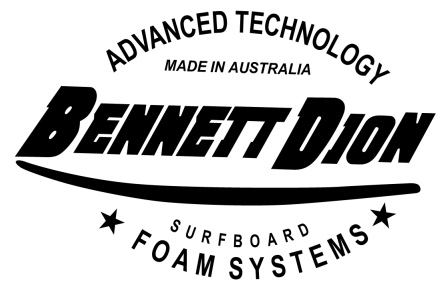

*gun boards for bigger waves*

# Bennett-Dion AUST.

Rocker  
6' 1/2"

**7'7"**  
**D2**

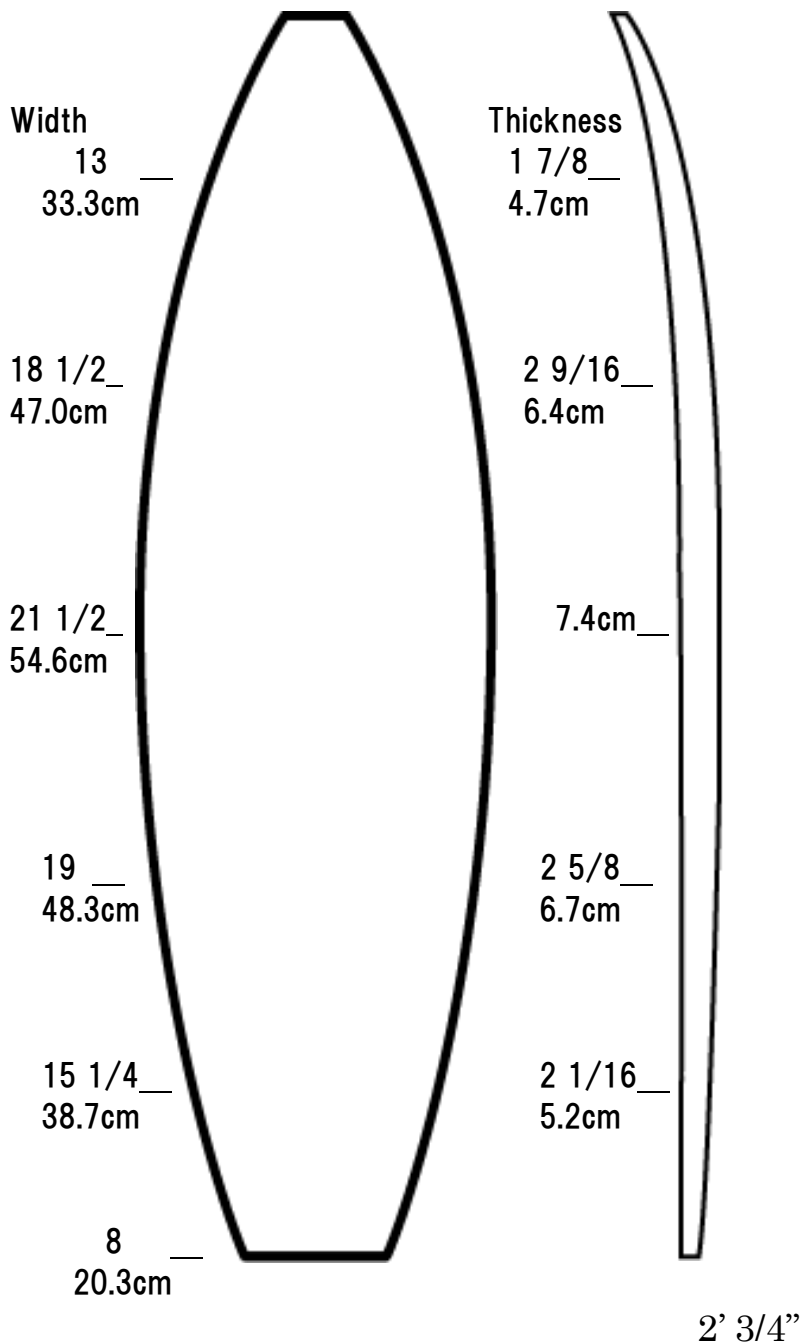

Actual Length	7'07" 231.4cm
Maximum Width	21 1/2 54.6cm
Maximum Thickness	7.4cm
History	1993
Rocker	D2
Weights	SSL
Stringer	

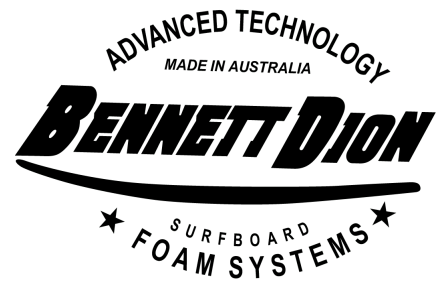

*gun boards for bigger waves*

Fish/Retro  
Type



# **Bennett-Dion AUST.**

## **Speed Shape Model**

### **5'10"NBSS**

Rocker 10.76cm

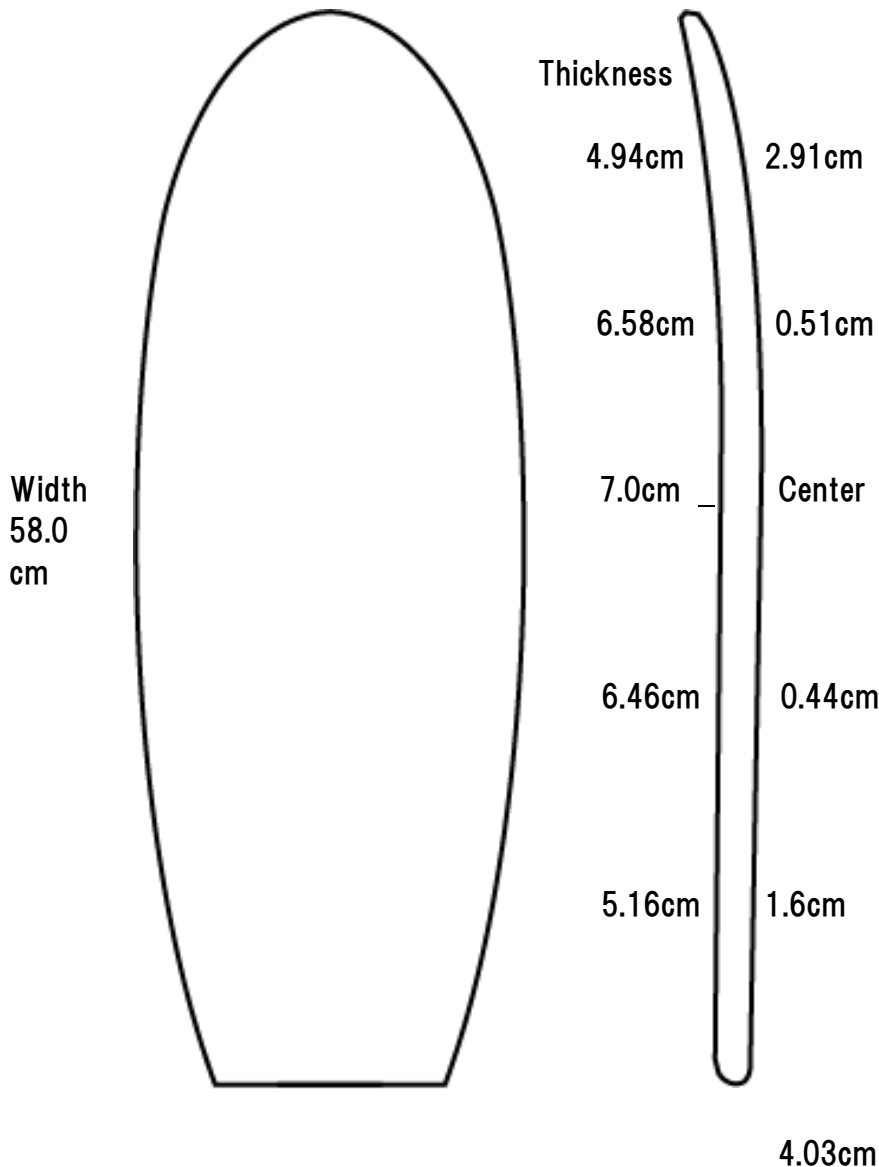

Deck Length	5'10"
Max. Width	-58.0cm
Max.Thickness	6.8 to 7.2cm
History	2016
Rocker	NB
Weights	UL
Stringer	1/8

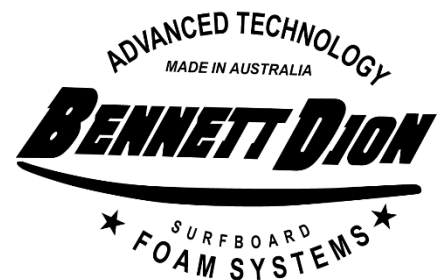

\*データ数値はあくまで参考値

\*アウトラインはカットされておりません (使用フォームによりアウトライン異なります)

*for retro or fish boards  
small miniboards also suited*

# **Bennett-Dion AUST.**

## **Speed Shape Model**

Rocker 11.37cm

# 6'2"NBSS

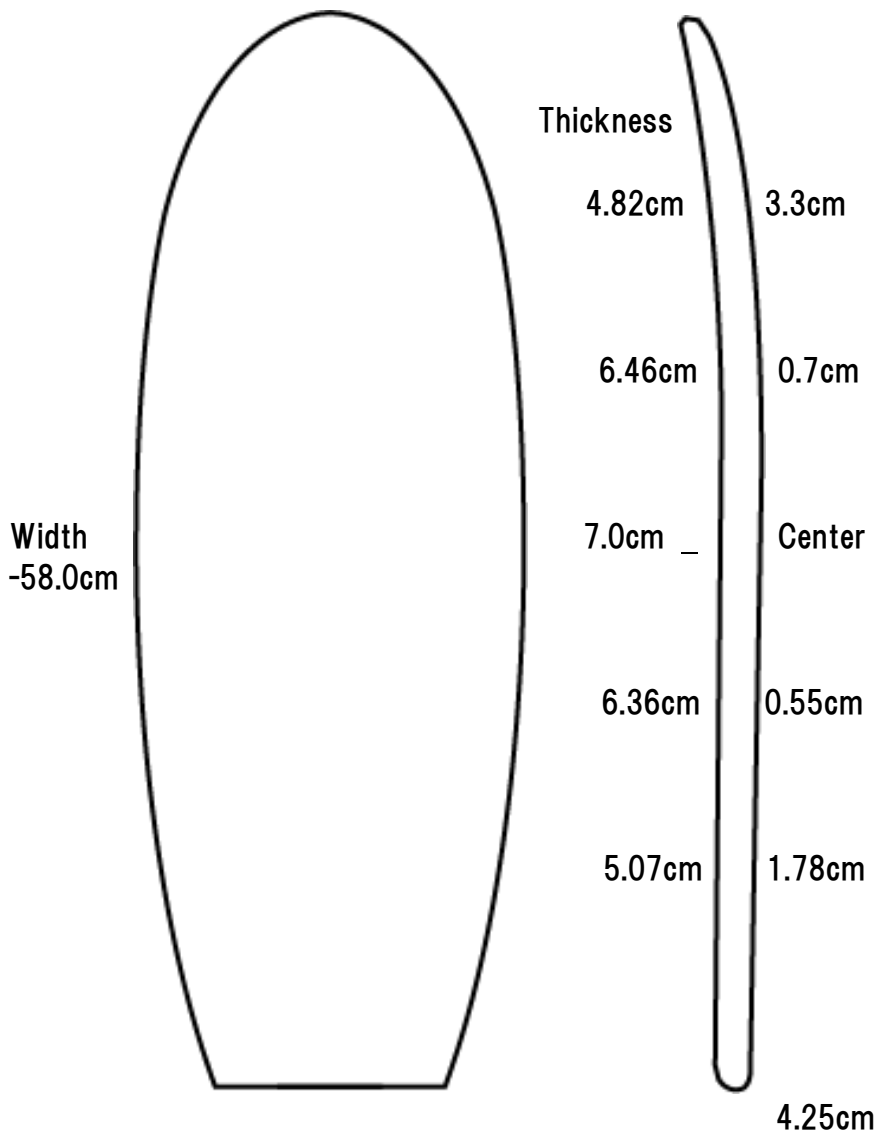

Deck Length	6'2"
Max. Width	58.0cm
Max.Thickness	6.8 to 7.2 cm
History	2016
Rocker	NB
Weights	UL
Stringer	1/8

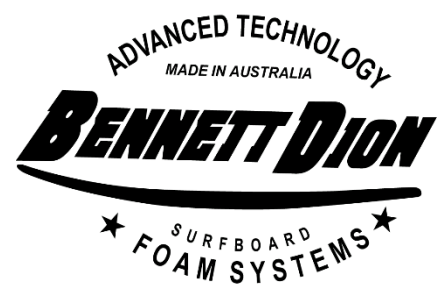

データ数値はあくまで参考値

\*アウトラインはカットされておりません (使用フォームによりアウトライン異なります)

*for retro or fish boards  
small minibords also good*

# Bennett-Dion AUST.

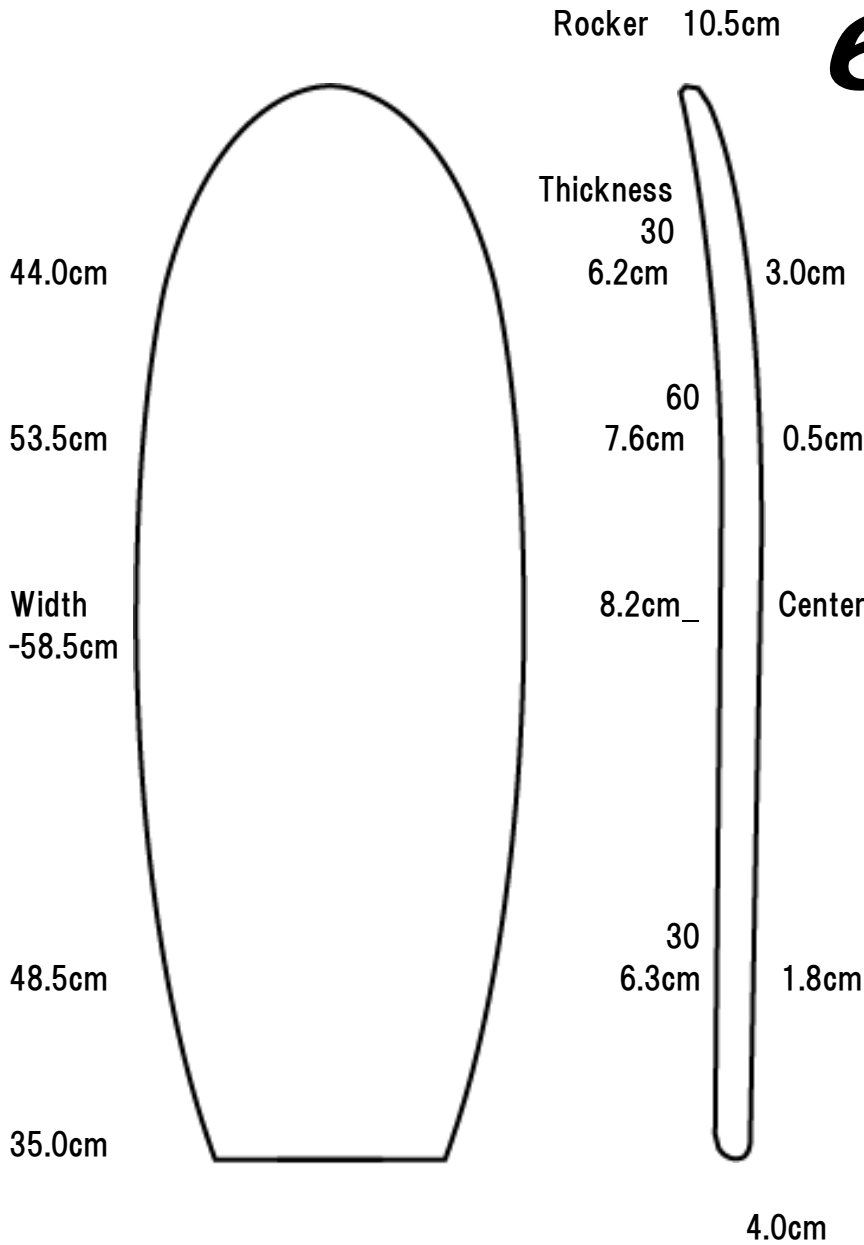

## 6'2" F

*DDR rocker*

Actual Length	6'2"
Max. Width	Under 58.5cm
Max. Thickness	8.2cm
History	2011
Rocker	DDR
Weights	SSL UL
Stringer	1/8

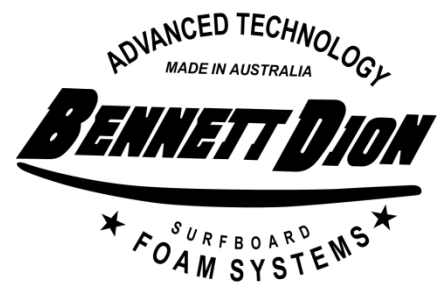

*for retro or fish boards*

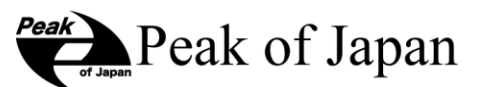

# **Bennett-Dion AUST.**

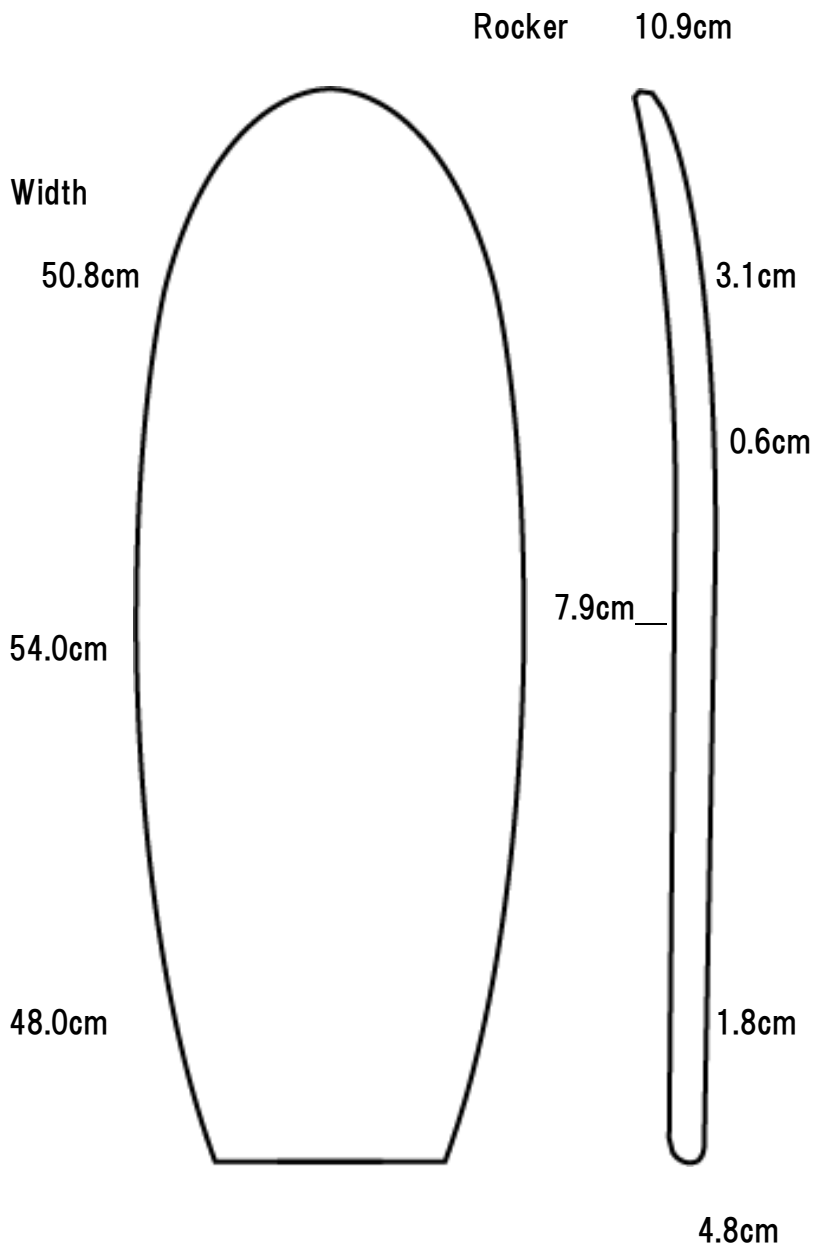

# 6'5"

## KB5

Actual Length	6'05" 197cm
Maximum Width	60.3cm
Maximum Thickness	7.9cm
History	
Rocker	KB5
Weights	SSL
Stringer	1/8

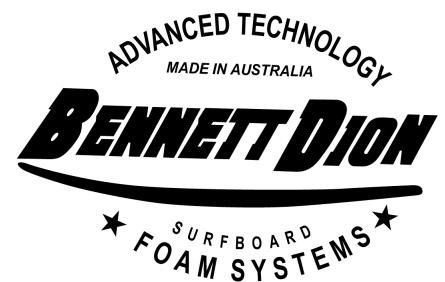

*originally designed for knee boards  
versatile for fish/retro boards*

# Bennett-Dion AUST.

# 6'9"

## F5

Width  
7 7/8 20.0cm

Rocker  
11.4cm

18 13/16  
47.8cm

Thickness  
2 1/8  
5.4cm

23 5/8  
60.0cm

3 1/16  
7.8cm

24 1/8  
61.3cm

8.4cm

18 7/8  
48.0cm

2 15/16  
7.5cm

18 3/8  
46.7cm

2 3/16  
5.6cm

12 15/16 22.7cm

3.8cm

Actual Length	6'09" 207.5cm
Maximum Width	24 1/8 61.3cm
Maximum Thickness	8.4cm
History	Terry Martin & Hobie 2007
Rocker	F5
Weights	SSL
Stringer	

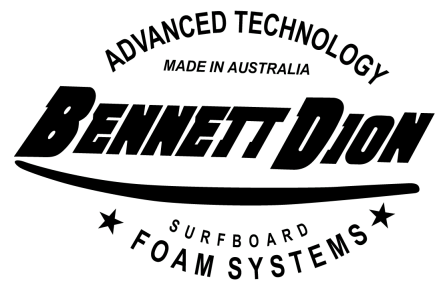

*for retro or fish boards  
low, natural curve*

# Bennett-Dion AUST.

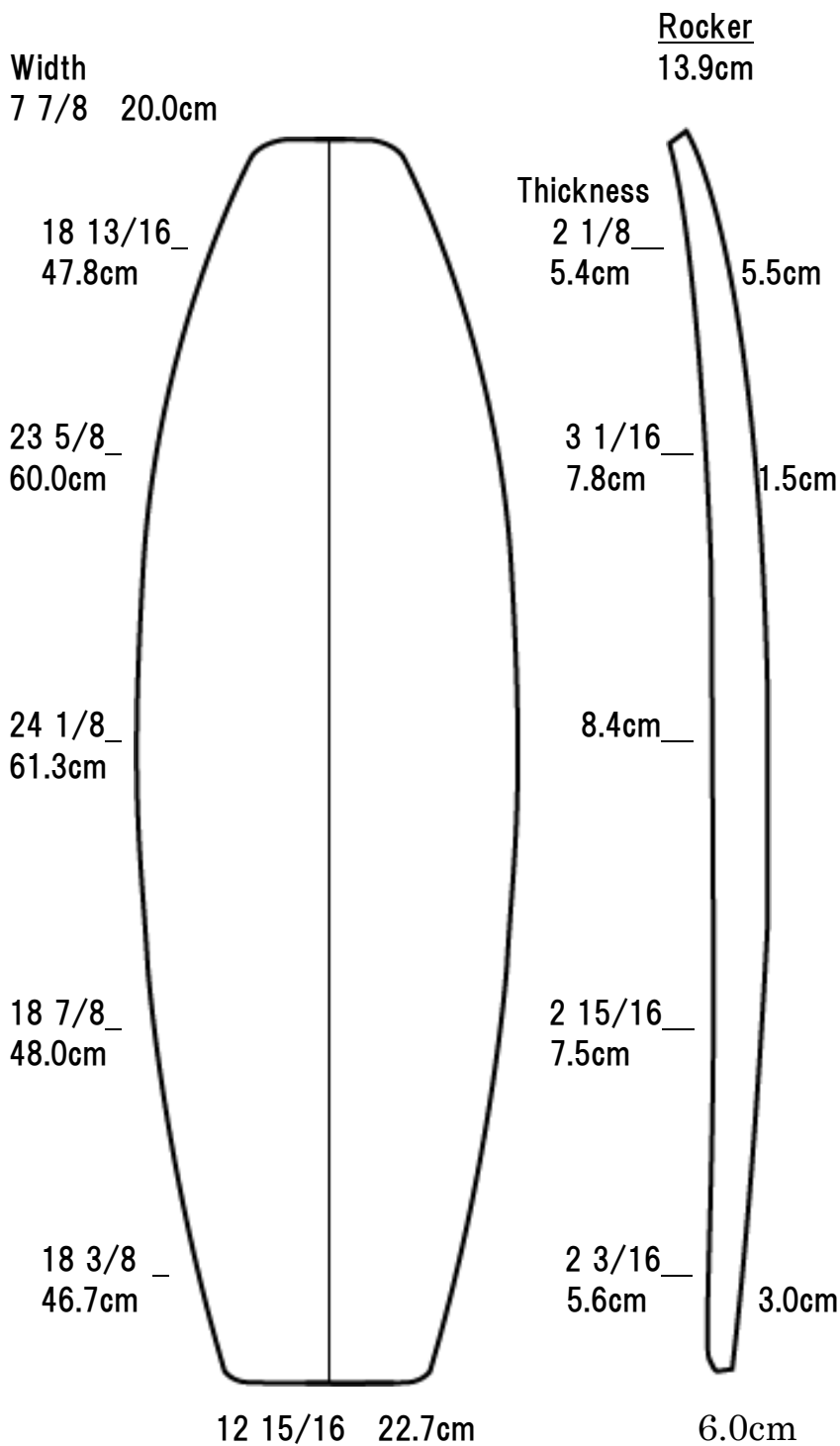

# 6'9"

## F2 Rocker

Actual Length	6'09" 207.5cm
Maximum Width	24 1/8 61.3cm
Maximum Thickness	8.4cm
History	Terry Martin & Hobie 2007
Rocker	F2
Weights	
Stringer	

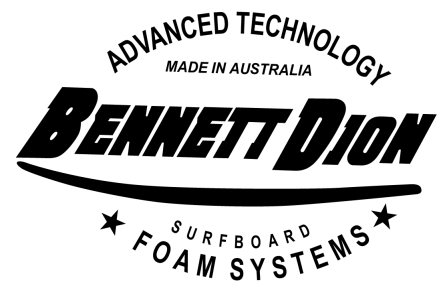

*for retro or fish boards  
curvy rocker*

Funboard Type

# **Bennett-Dion AUST.**

## **Speed Shape Model**

Rocker  
10.6cm

# **7'3MMss**

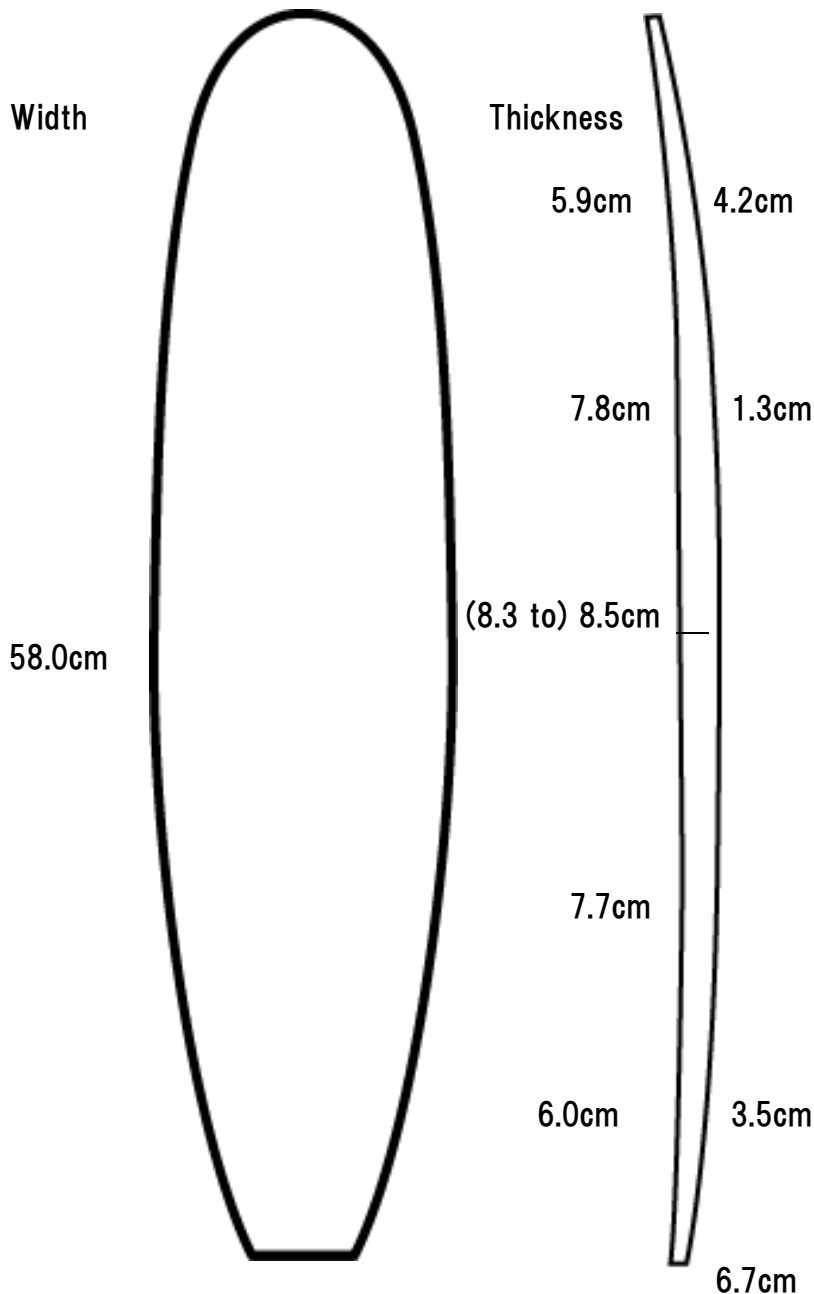

<b>Actual Length</b>	<b>223.0cm</b>
<b>Max.Width</b>	<b>58.00cm</b>
<b>Max.Thickness</b>	<b>8.3 to 8.5cm</b>
<b>History</b>	<b>2013</b>
<b>Rocker</b>	
<b>Weights</b>	<b>SSL</b>
<b>Stringer</b>	<b>1/4</b>

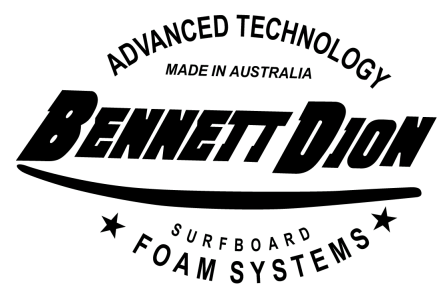



# Bennett-Dion AUST.

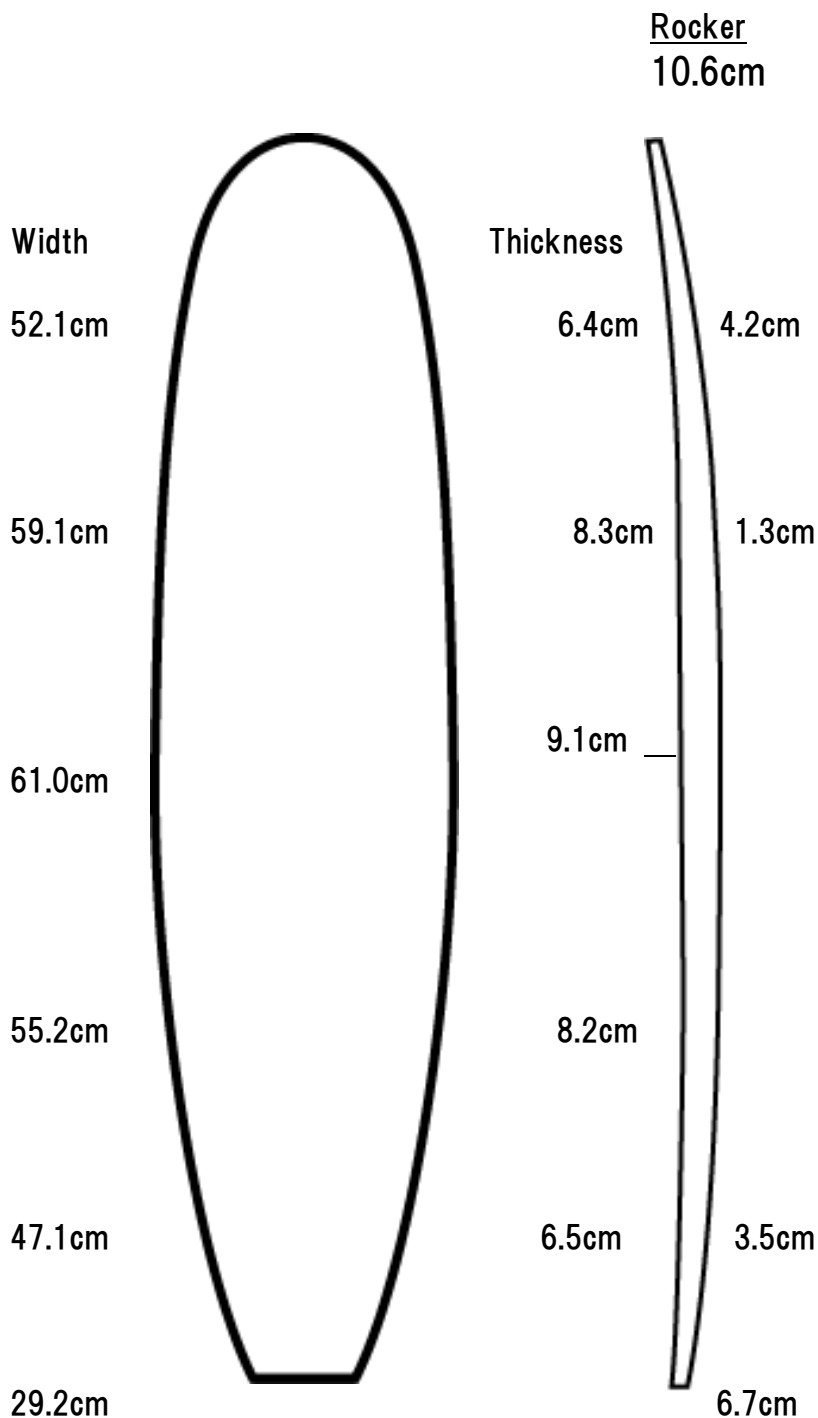

## 7'3mm MM21 Rocker

Actual Length	7'03" 222.0cm
Max.Width	61.00cm
Max.Thickness	9.1cm
History	2011 NEW
Rocker	MM21
Weights	SSL
Stringer	1/4

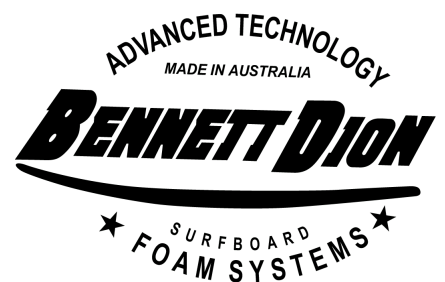

This newly made 7'3 is thicker and wider all over than the original, ideal for small mini mals, retro fun shapes, big guy fishes or single fins and mini-longs. Will suit a wide range of rockers and be easy to machine and hand shape.

# **Bennett-Dion AUST.**

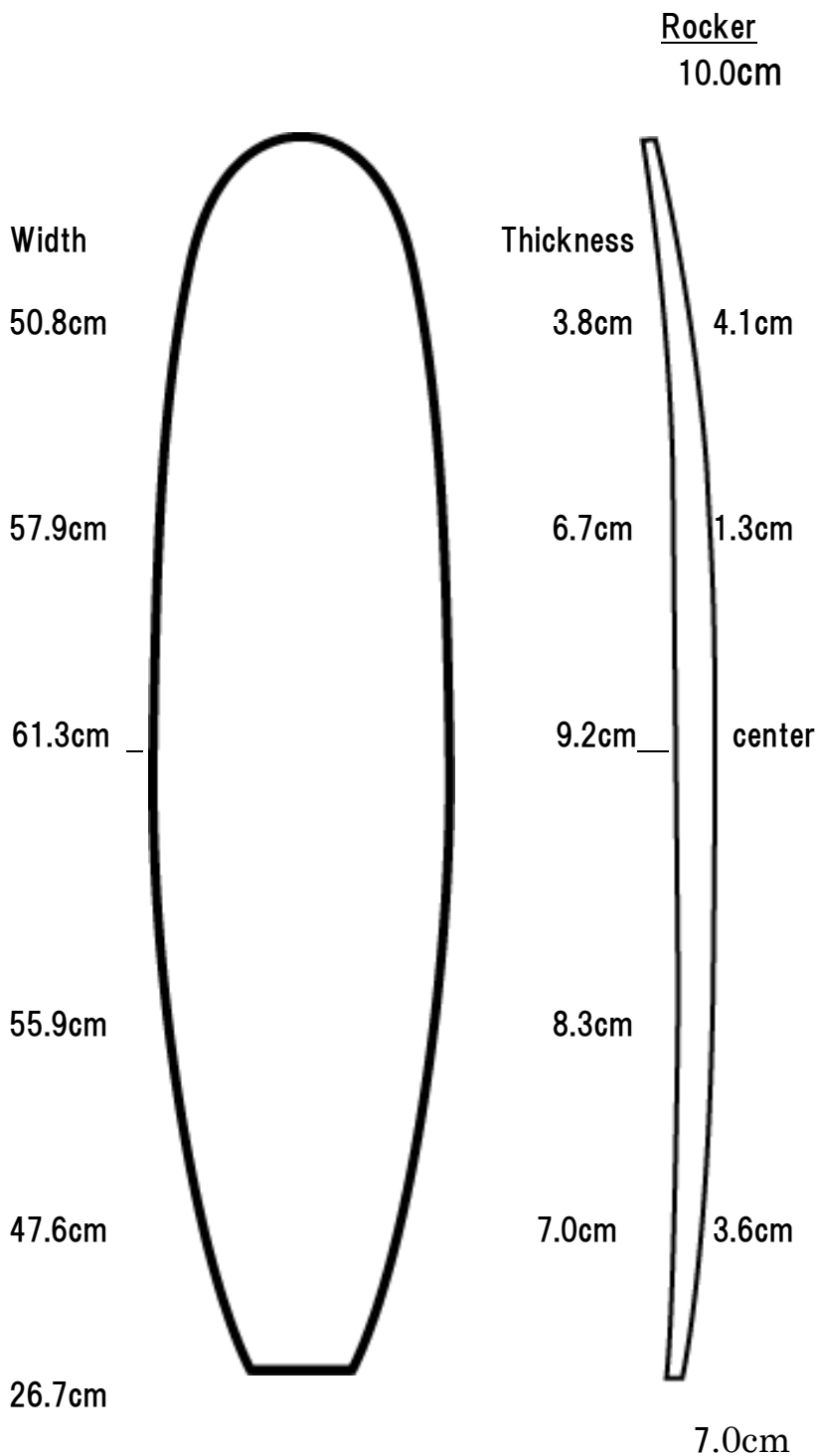

**7'7mm**  
**MM21 Rocker**

<b>Actual Length</b>	7'07" 1/4 234.69cm
<b>Max.Width</b>	61.60cm
<b>Max.Thickness</b>	9.2cm
<b>History</b>	2011 NEW
<b>Rocker</b>	MM21
<b>Weights</b>	SSL
<b>Stringer</b>	1/4

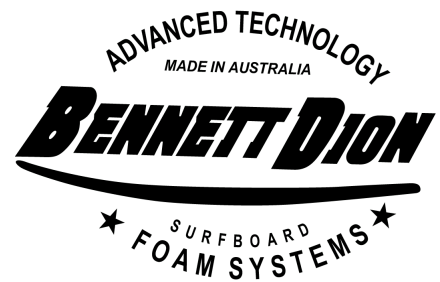

Based on the original 7'7 Mini Mal with added width and thickness throughout. Will suit a wider range of plan shapes and rocker templates for mini mals, big guy fun shapes, large fish, retro shapes and mini longs. Ideal to either machine or hand shape.

# Bennett-Dion AUST.

# 8'4"

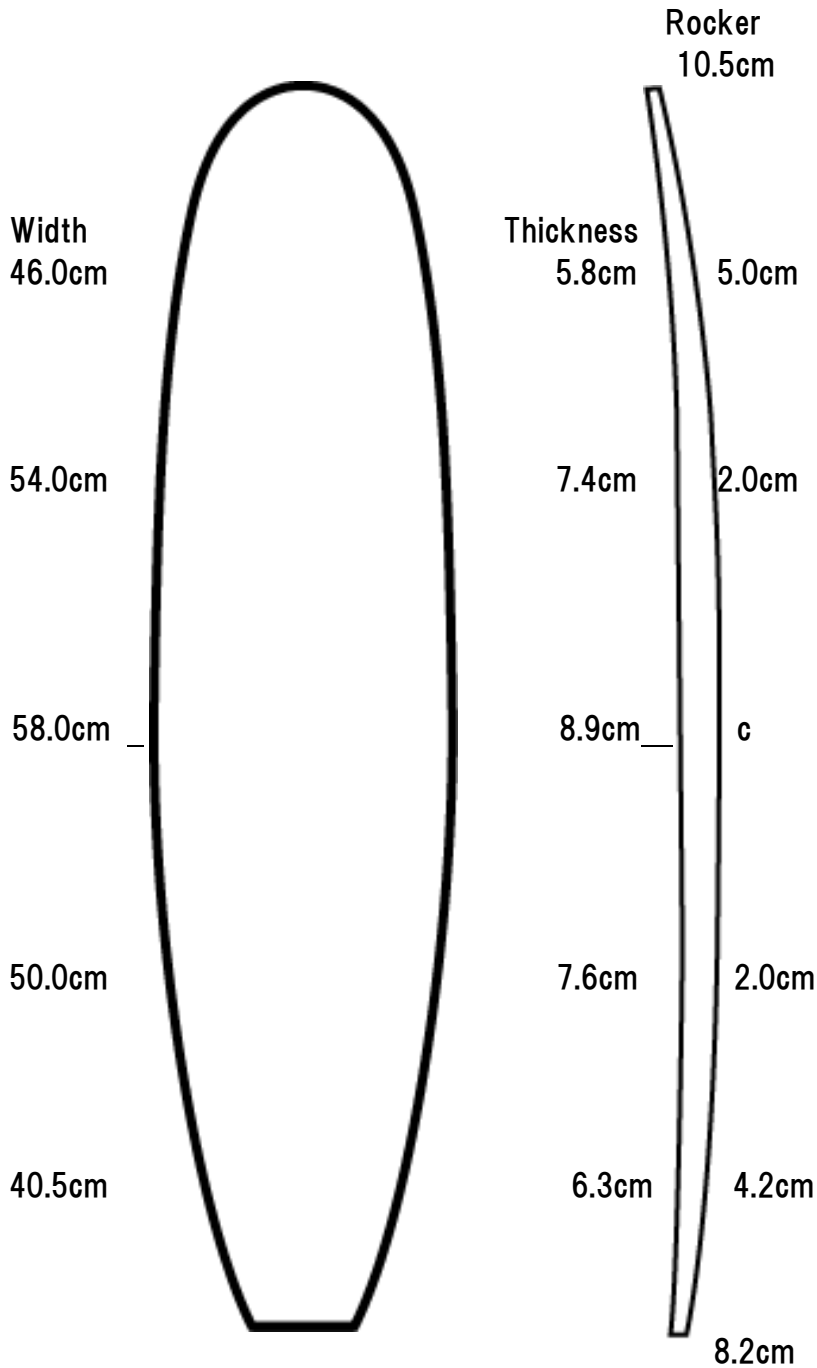

Actual Bottom Length	256.5cm
Max. Width	58.0cm
Max.Thickness	8.9cm
History	2015
Rocker	SKMZ
Weights	SSL
Stringer	1/4 Redwood Multi stringer

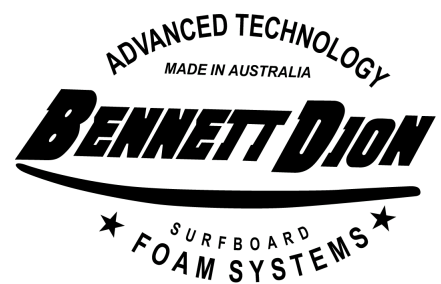

\*数値はあくまで目安参考値

Longboard  
Type

# **Bennett-Dion AUST.**

## **Speed Shape Model**

# 9'2"ss

## Performance

## Model

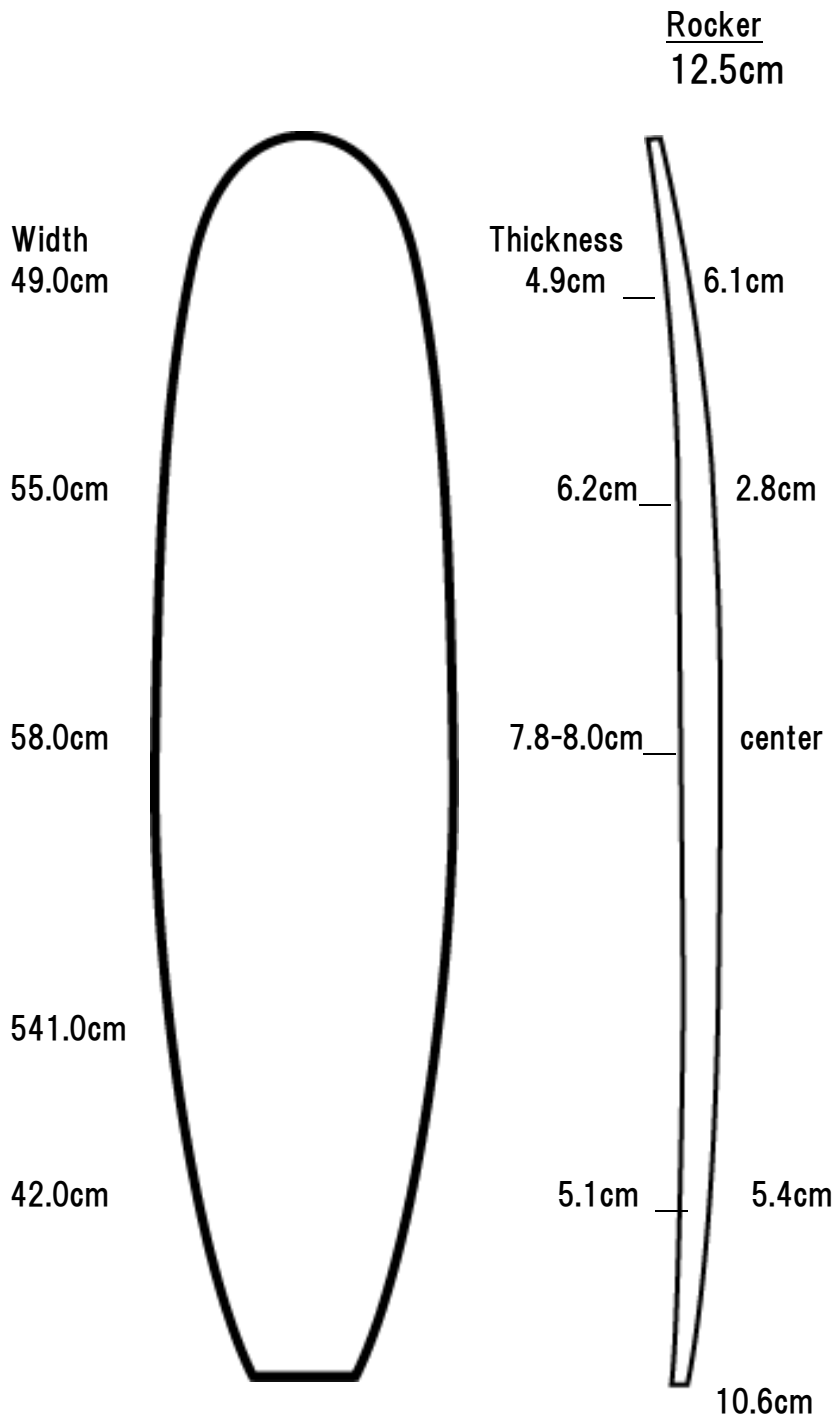

Actual Length	9'2"
Max. Width	Under 58.0cm
Max. Thickness	7.8-8.0cm
History	2009
Rocker	SS
Weights	SSL UL TP
Stringer	1/4

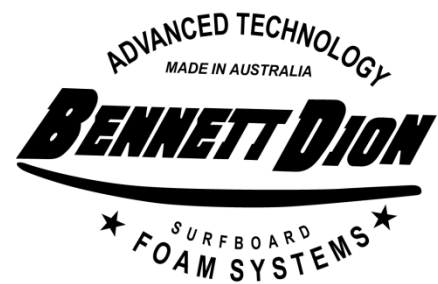

データ数値 個体差あり

high performance model, tail flip

# Bennett-Dion AUSTRALIA

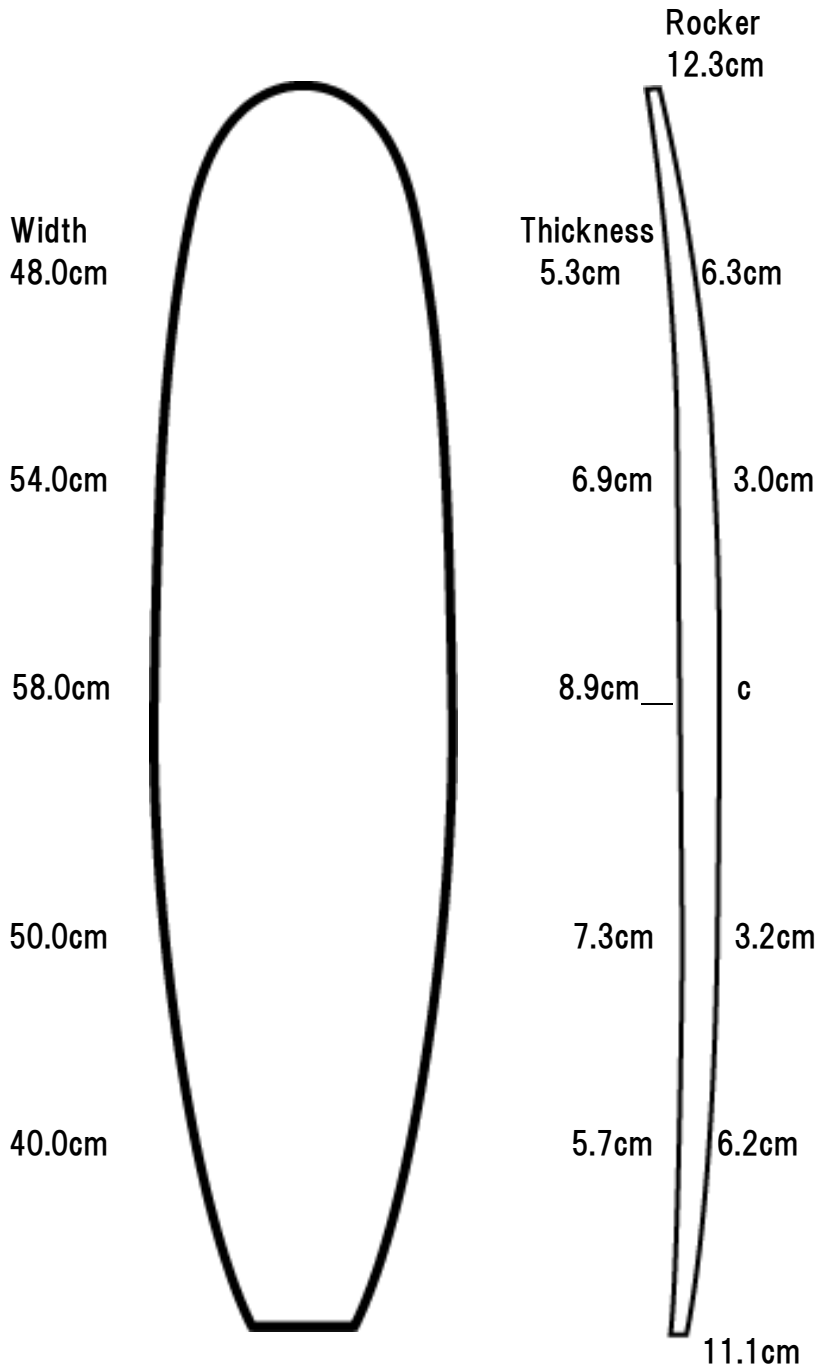

# 9'6

## performance

Actual Bottom Length	292.5cm
Max. Width	58.0cm
Max.Thickness	8.9cm
History	2015
Rocker	V1 performance
Weight	Normal
Stringer Variation	

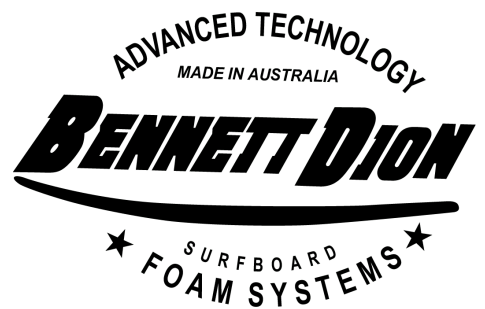

*Newly re-designed curve named as V1, suitable for the latest modern performance design*

\*数値はあくまで目安参考値

# Bennett-Dion AUSTRALIA

## 9'6 AR2

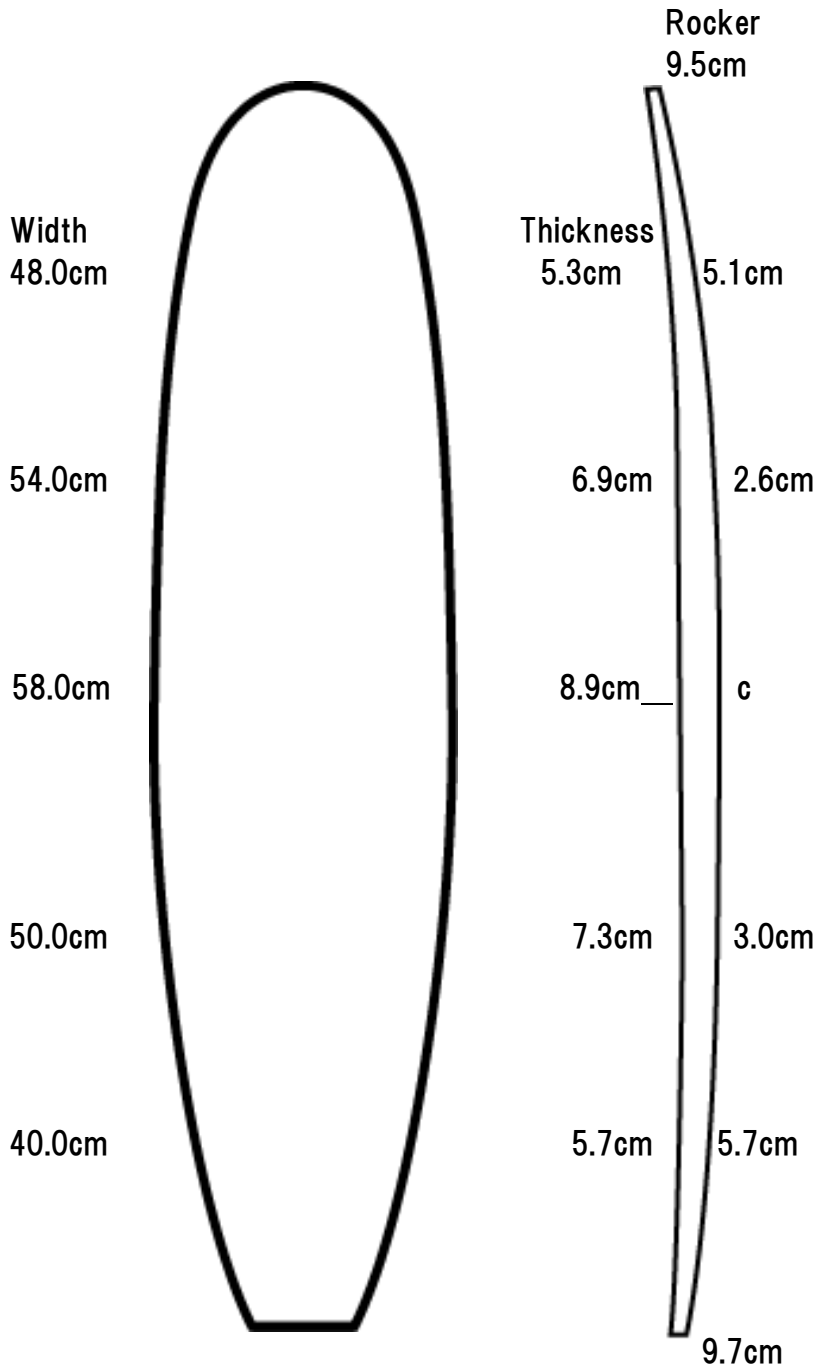

Actual Bottom Length	292.5cm
Max. Width	58.0cm
Max.Thickness	8.9cm
History	2016
Rocker	AR2
Weight	Normal
Stringer Variation	

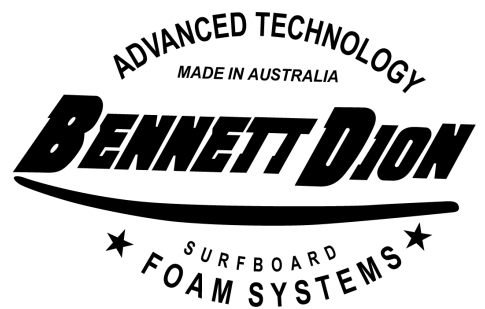

*Newly re-designed curve for all round design through classic*

\*数値はあくまで目安参考値

# Bennett-Dion AUSTRALIA

## 9'8 CL3

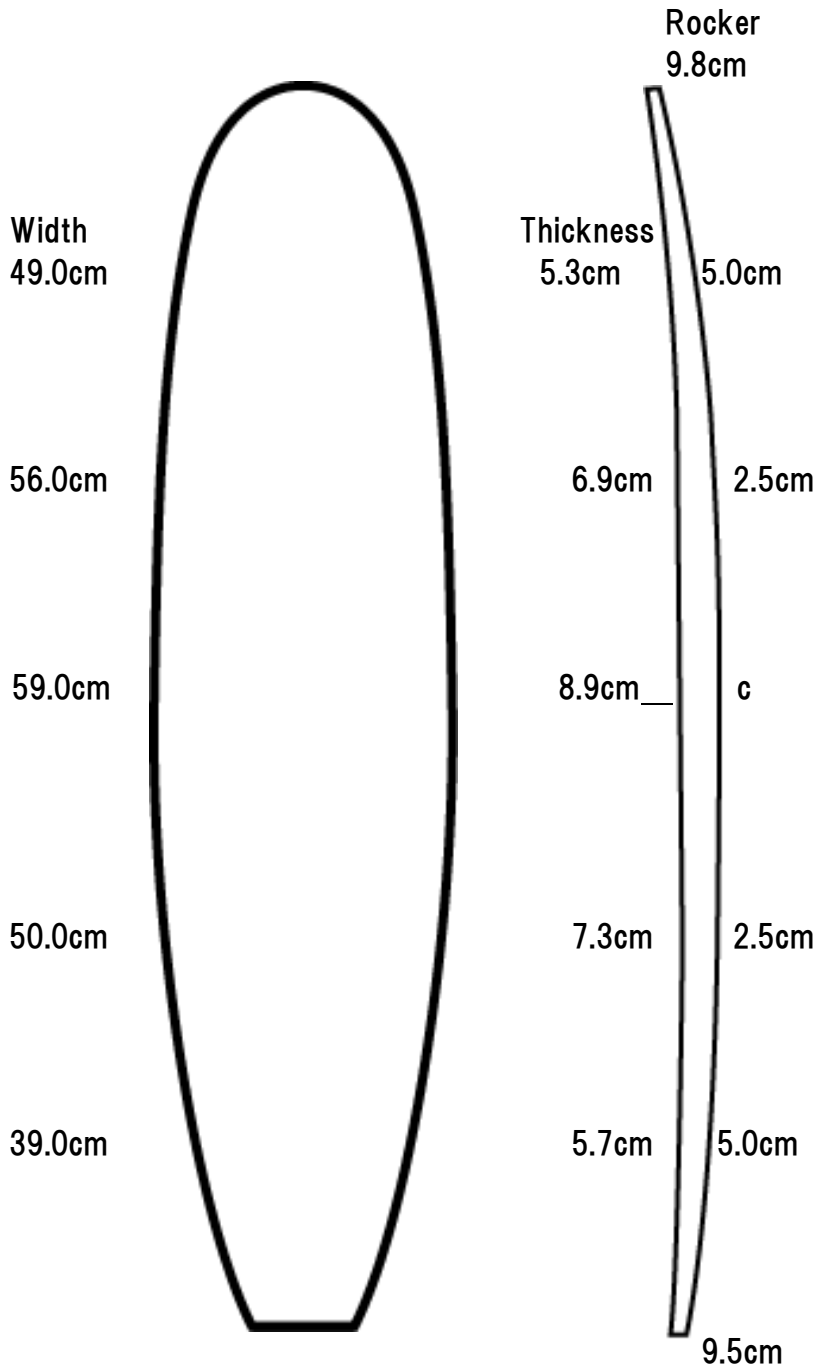

Actual Bottom Length	296.0cm
Max. Width	59.0cm
Max.Thickness	8.9cm
History	2016
Rocker	CL3
Weight	Normal
Stringer Variation	Redwood Balsa 2stringer 3stringer 4 stringer etc.

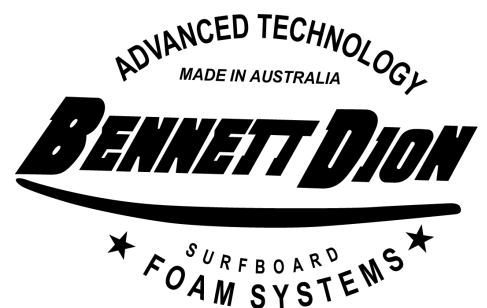

*Newly re-designed curve for all classic design, latest or old school or whatever...*

\*数値はあくまで目安参考値



# Bennett-Dion AUST.

# 10'2"

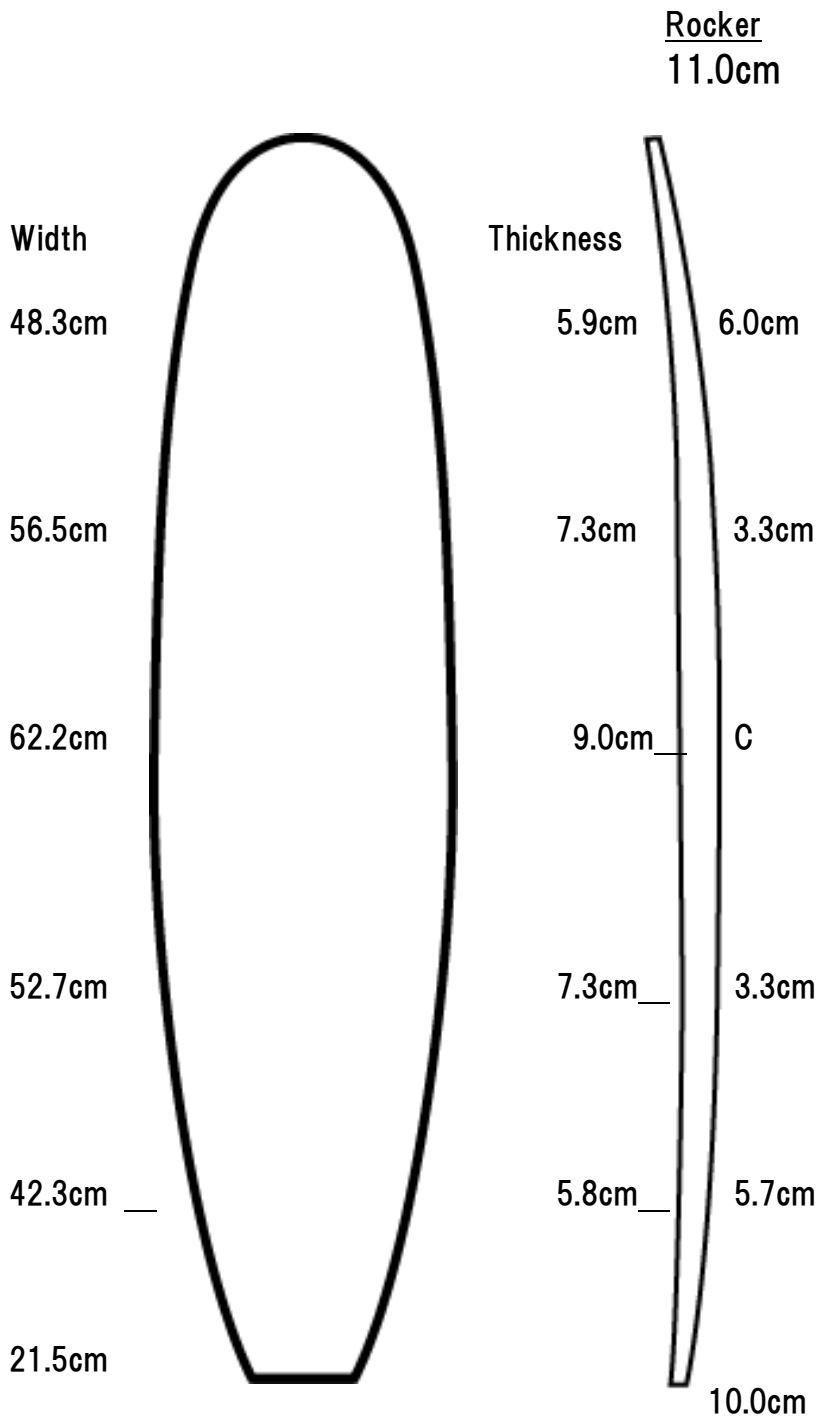

<b>Actual Bottom Length</b>	312.0cm
<b>Max Width</b>	62.2cm
<b>Max Thickness</b>	9.0cm
<b>History</b>	2014
<b>Rocker</b>	BB
<b>Weights</b>	SSL
<b>Stringer</b>	

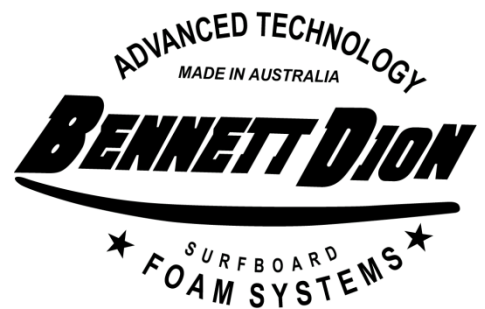

数値はあくまで目安参考値

EPSS

# Bennett-Dion EPS Foam System

## EPS 6'7 DD

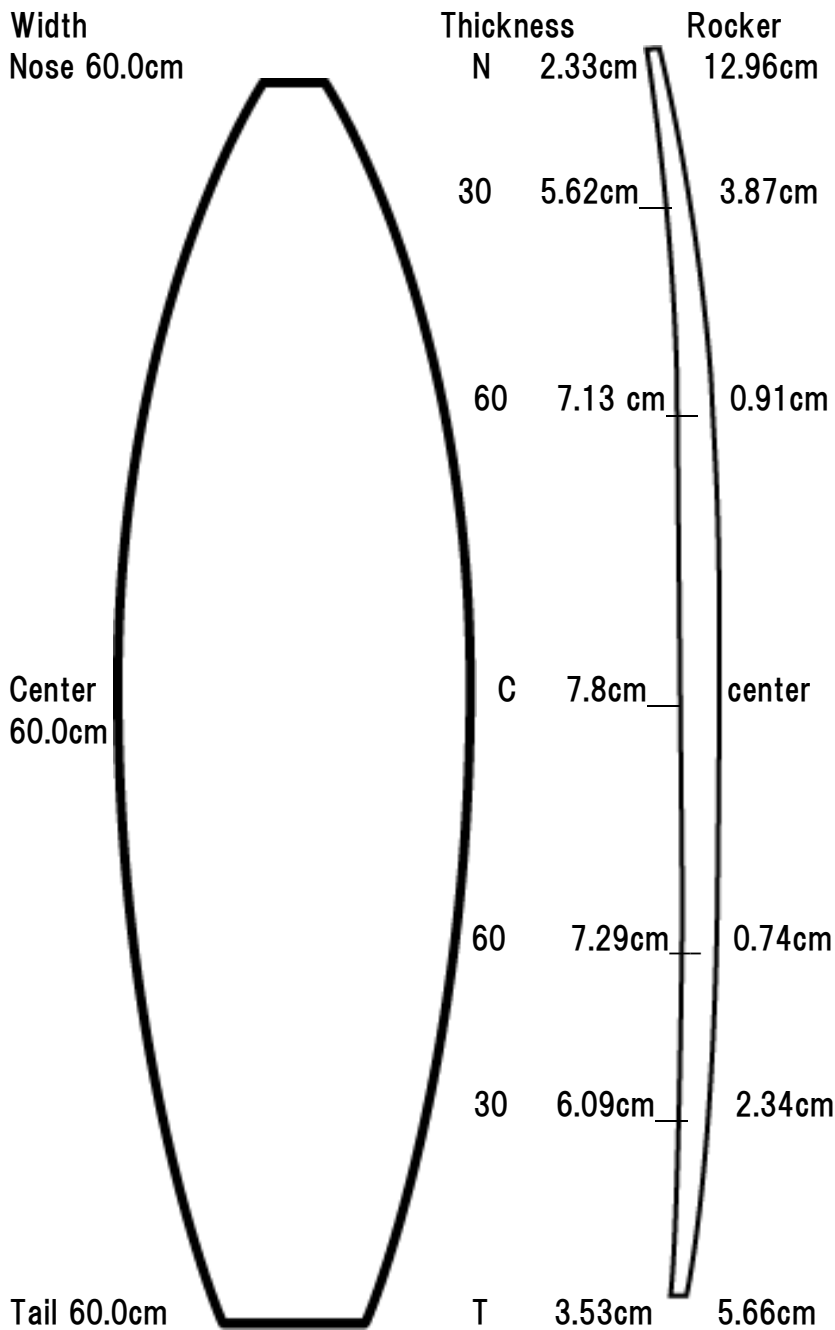

Deck Length	201cm
Max. Width	60.0cm
Max.Thickness	7.8cm
History	2016
Rocker	DD
Weights	x40 · x 30
Stringer	1/8 No stringer

\*数値はあくまで参考値

# Bennett-Dion EPS Foam System

## EPS 6'7 FR

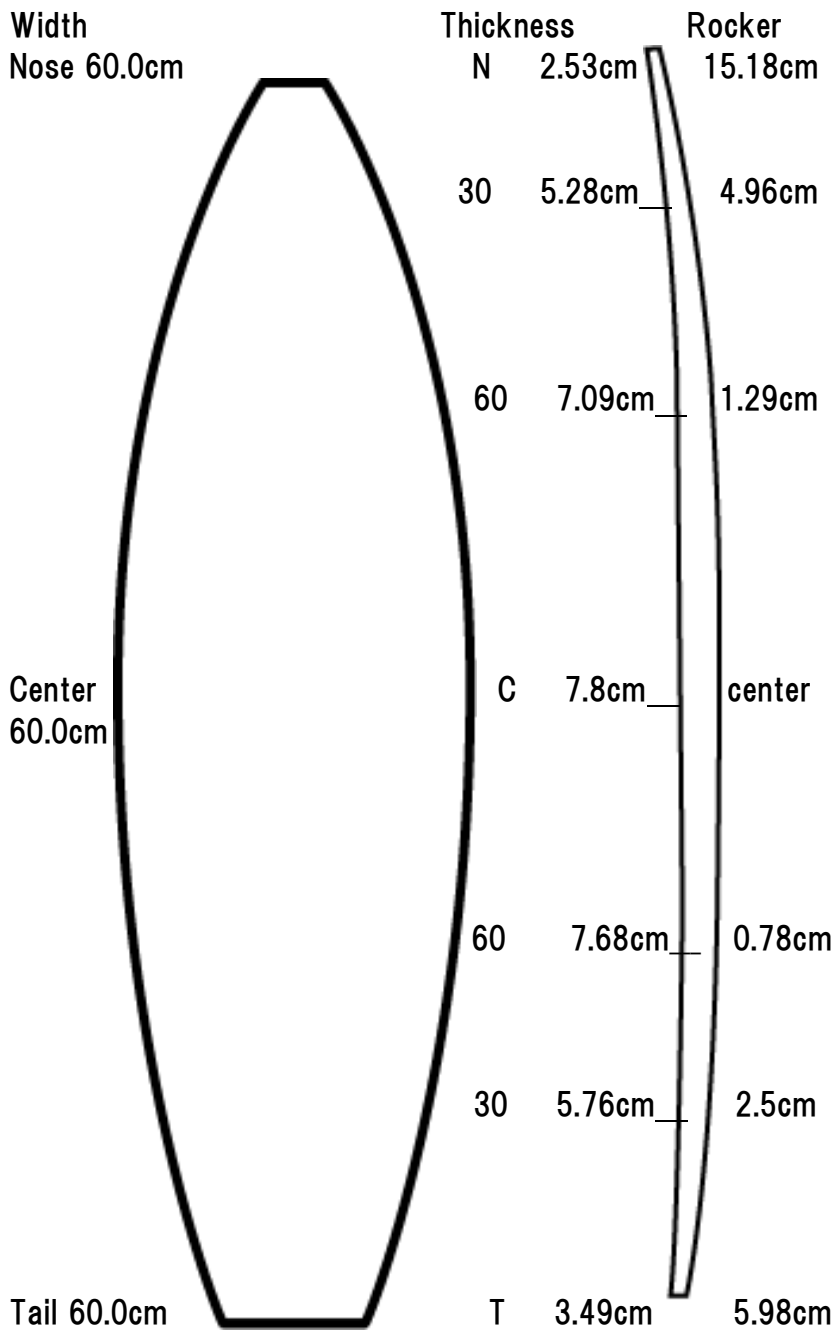

Deck Length	201cm
Max. Width	60.0cm
Max.Thickness	7.8cm
History	2016
Rocker	FR
Weights	x40 · x30
Stringer	1/8 No stringer

\*数値はあくまで参考値

# Bennett-Dion EPS

## EPS 9'4

### V1 Performance

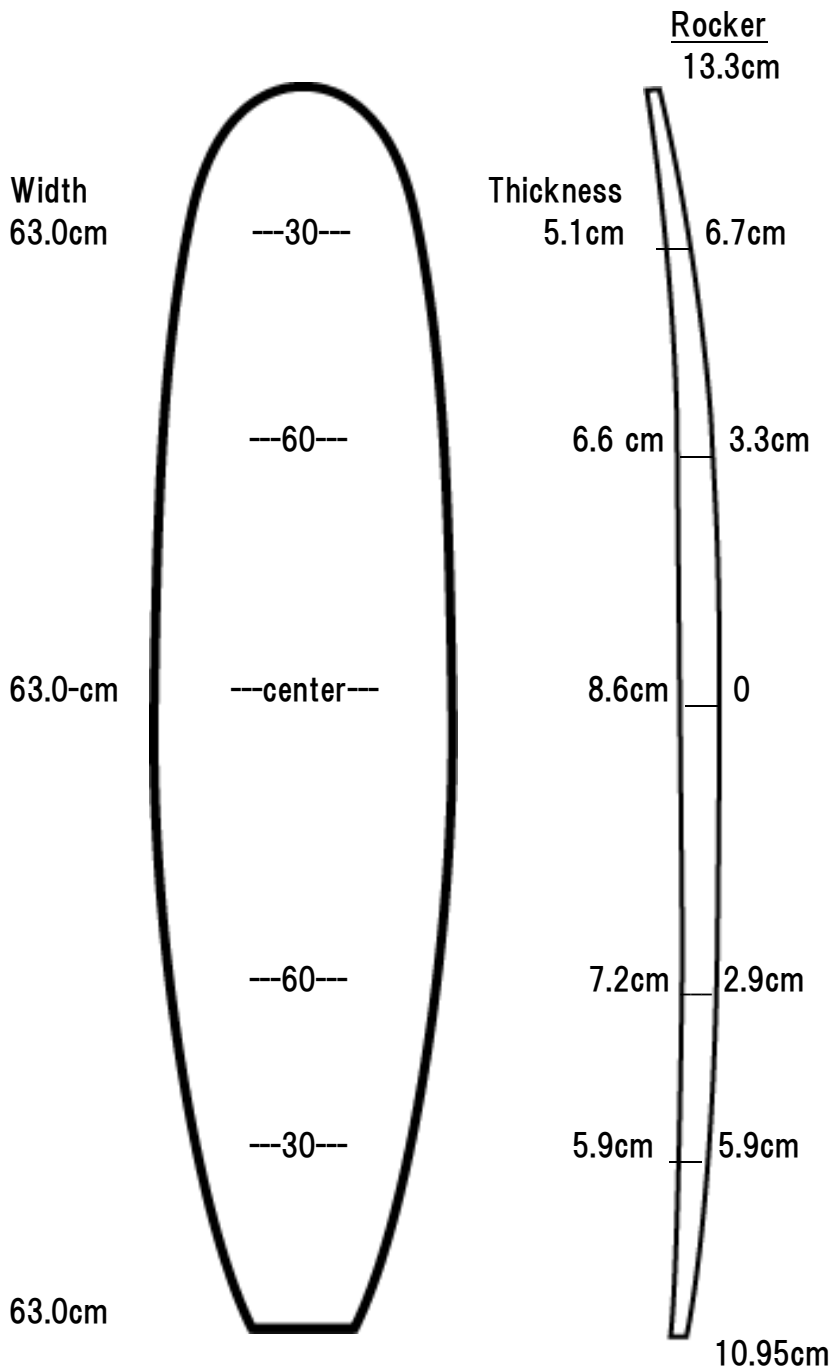

Actual Length	Deck	285.0cm
		9'4"
Max. Width		63.0cm
Max.Thickness		8.6cm
		Extra Fat
History		2018
Rocker		V1
Weight		normal
Stringer		ASK

\* 数値はあくまで目安の参考値

# Bennett-Dion EPS

## EPS 9'4

### V2 all-round

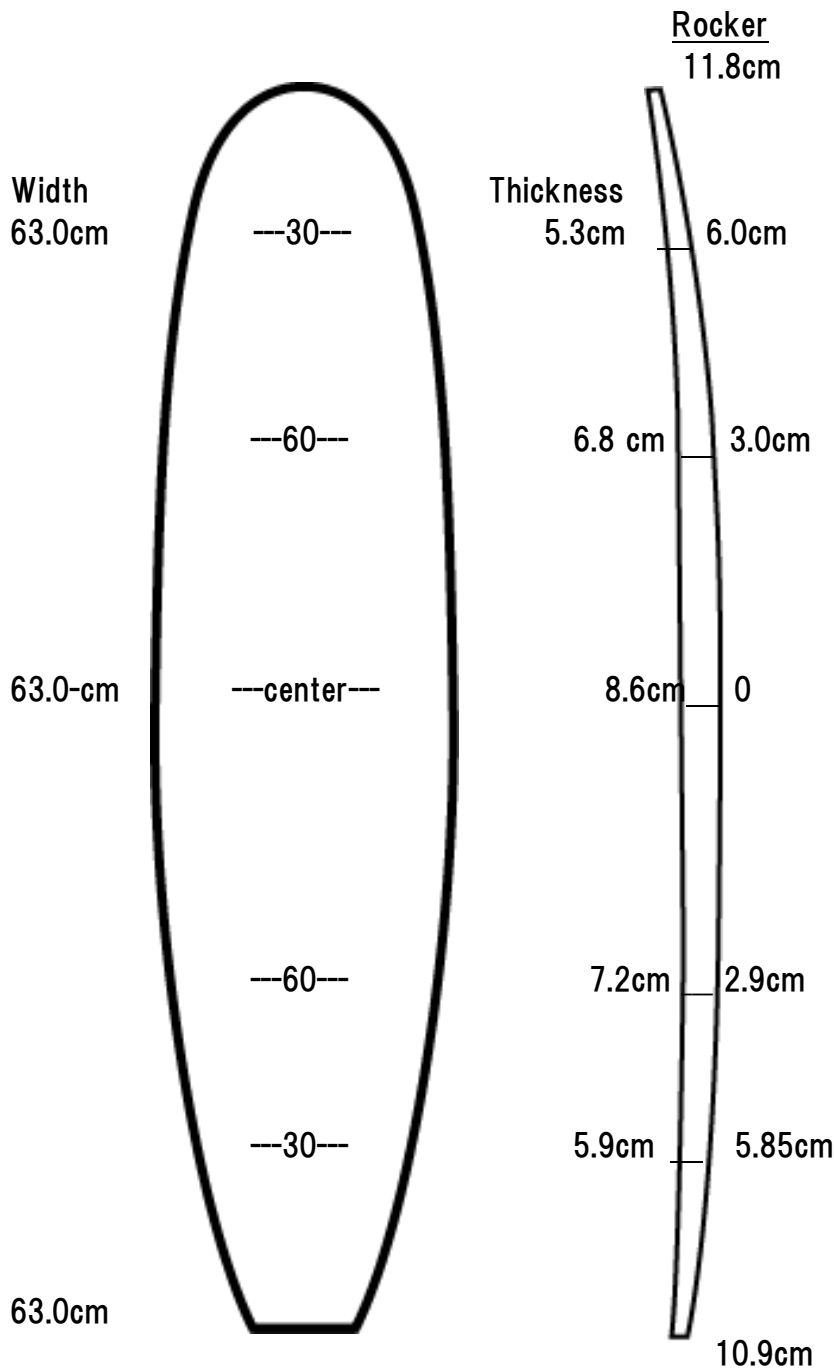

Actual Length	Deck	285.0cm 9'4"
Max. Width		63.0cm
Max.Thickness		8.6cm Extra Fat
History		2018
Rocker		V2
Weight		normal
Stringer		ASK

\* 数値はあくまで目安の参考値

# Bennett-Dion EPS

## EPS 9'4

### V3 classic

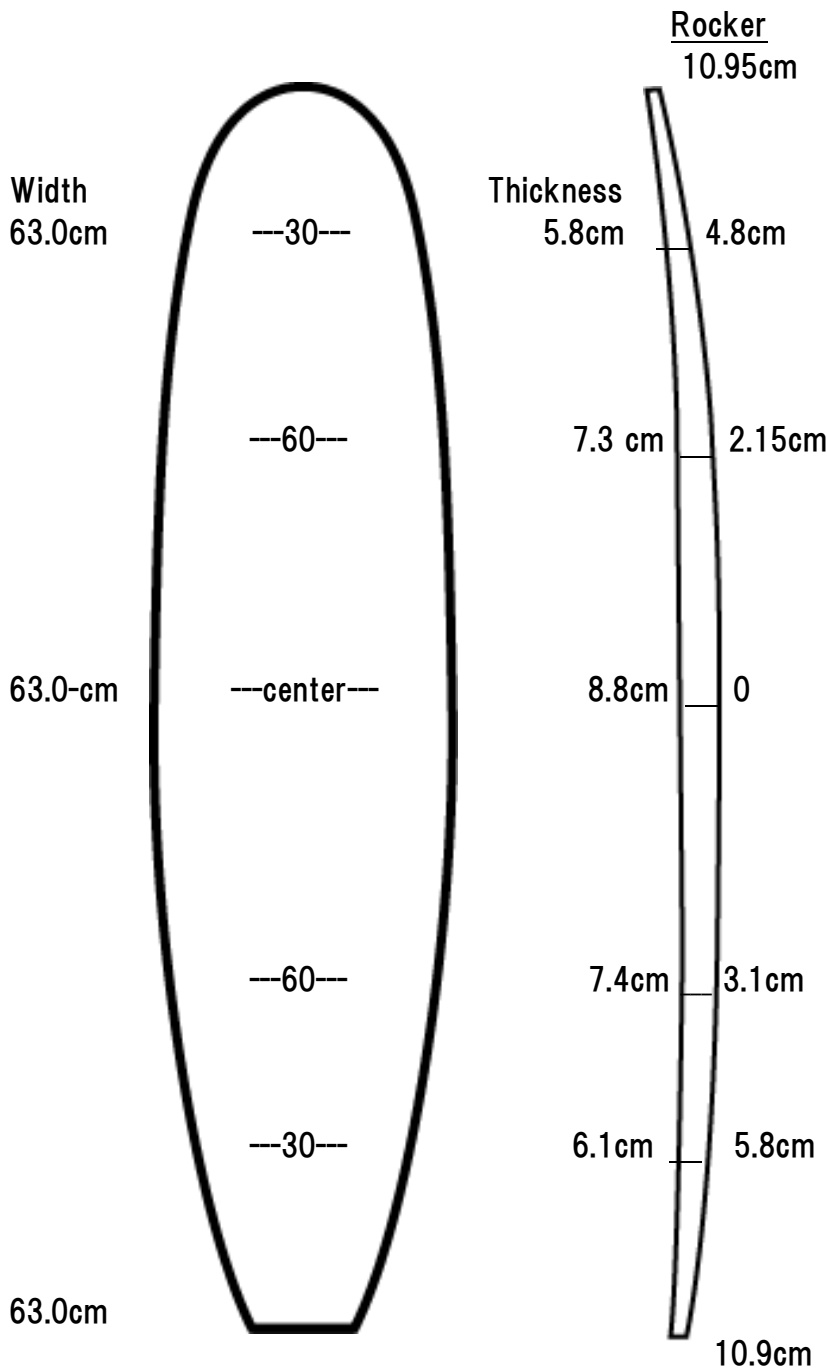

Actual Length	Deck	285.0cm
		9'4"
Max. Width		63.0cm
Max.Thickness		8.8cm
		Extra fat
History		2019
Rocker		V3
Weight		normal
Stringer		ASK

\* 数値はあくまで目安の参考値

**EPS**

# EPS 10'1''

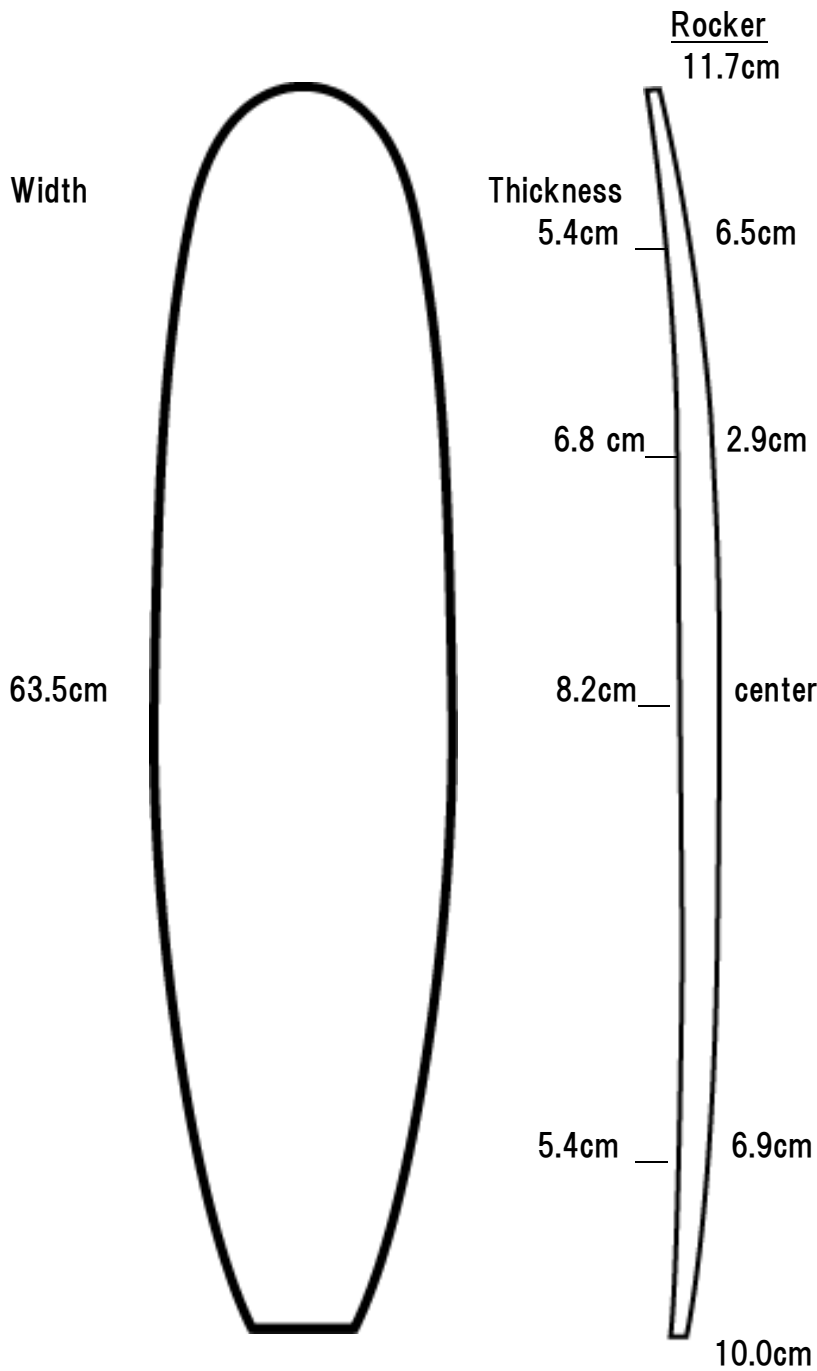

<b>Actual Length</b>	
<b>Max. Width</b>	
<b>Max.Thickness</b>	<b>63.5cm</b>
<b>History</b>	<b>2011</b>
<b>Rocker</b>	
<b>Weights</b>	<b>x40</b>
<b>Stringer</b>	<b>1/4</b>

データ数値 個体差あり